

■ PROTECO®

skleník obloukový 310 x 205 x 205 cm

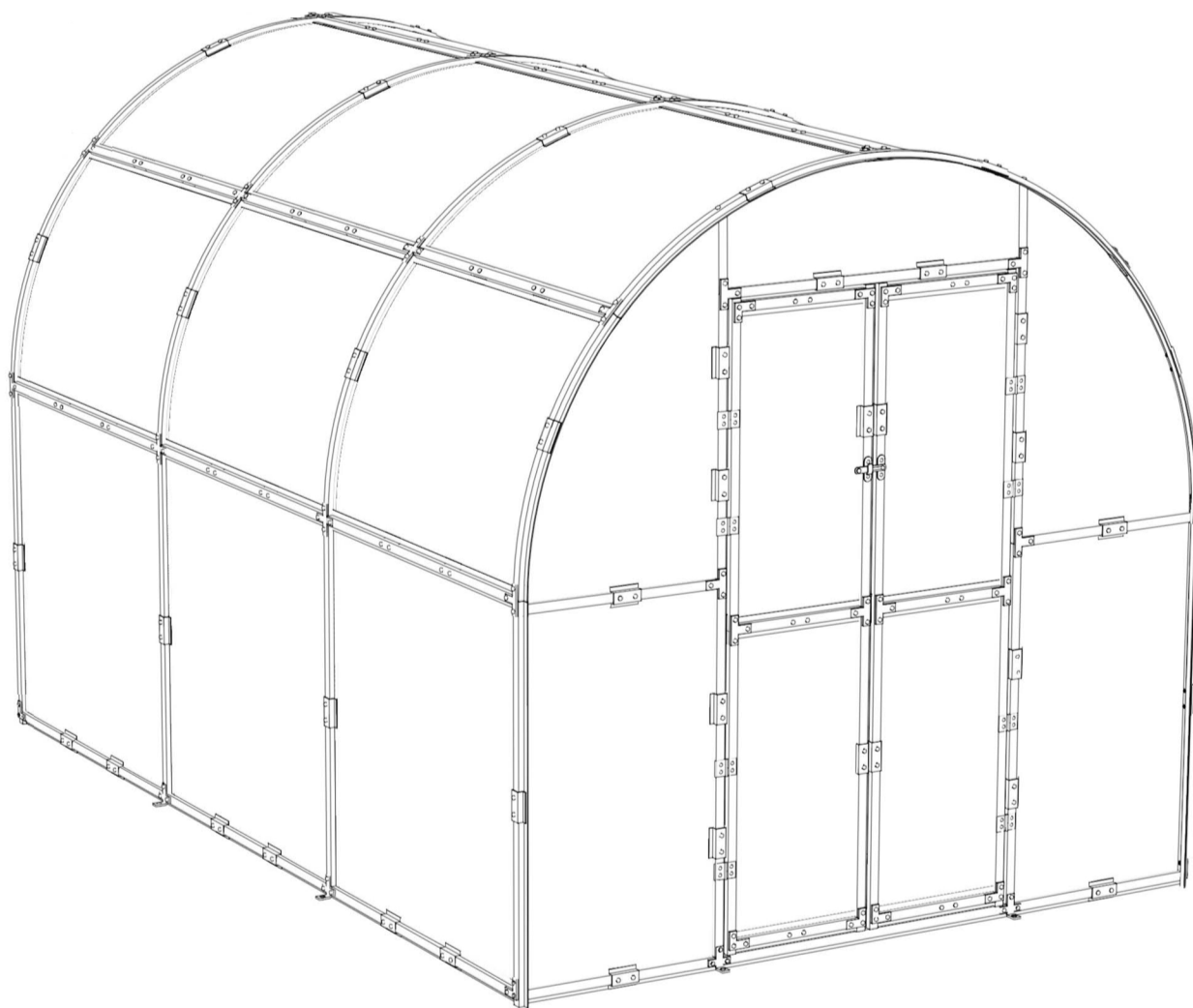

CZ

Upozornění

Pro správnou instalaci výrobku postupujte dle tohoto návodu.

1. Skleník skládejte ve 2 osobách. Doba instalace se pohybuje mezi 4-5 hodinami.

2. Pro počáteční instalaci používejte výhradně ruční nářadí. Elektrické nářadí doporučujeme použít v závěru pro dotažení šroubů.

3. Šrouby nedotahujte, dokud nemáte do profilů zasazené polykarbonátové desky. V opačném případě vám nepůjdou desky do profilů zasadit.

4. Mějte na mysli, že tento skleník není zcela vodotěsný. Při větších srážkách tak může dojít k prosakování vody.

Ukotvení

Skleník musí stát na rovné ploše po celém obvodu jeho základny a na takovém podloží, aby vydrželo uchycení základny skleníku.



Základ pro ukotvení skleníku musí být vyhotoven ve vodorovné poloze z pevného stabilního materiálu (tak aby nemohlo dojít ke změnám jeho vlastností, rozměrů a deformacím).



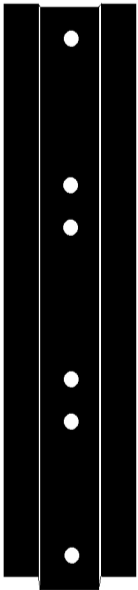
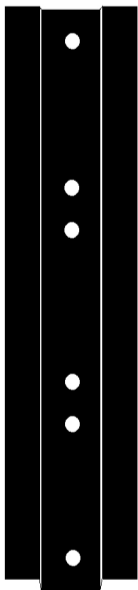
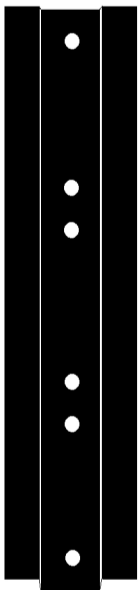
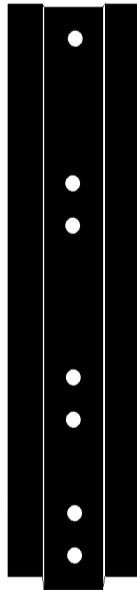
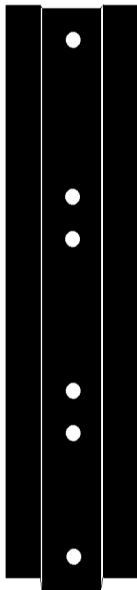
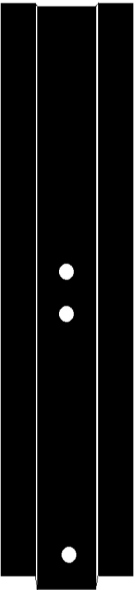
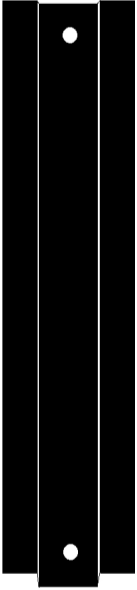
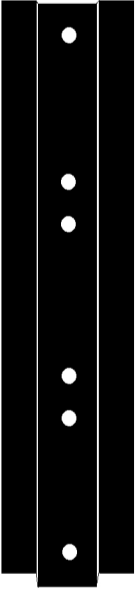
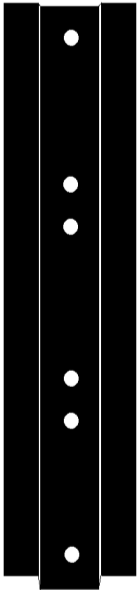
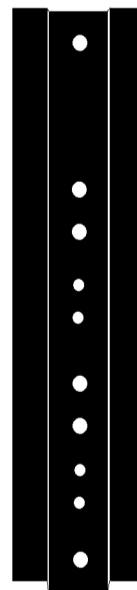
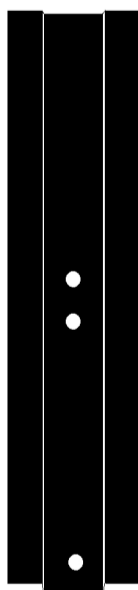
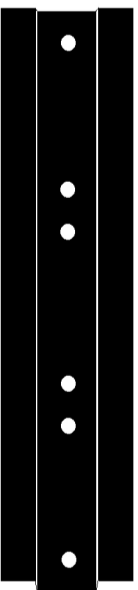

Kotvící prvky (šrouby, kotvy) základny skleníku musí být upevněny v základu skleníku pevně tak, aby nemohlo dojít k pohybu skleníku, ale zároveň nesmí dojít při dotahování kotvících prvků k deformaci skleníku. Základ má zajistit stabilitu konstrukce, být vodorovný a všechny jeho čtyři strany na sebe být navzájem kolmé.

Pokud máte sebemenší pochybnosti o tom, jestli podloží skleník udrží a hrozilo by, že skleník bude uchycen nedostatečně, tak patky nosných oblouků zalijte do betonu nebo skleník postavte jinde. Jednoznačně doporučujeme kotvící body zabetonovat.

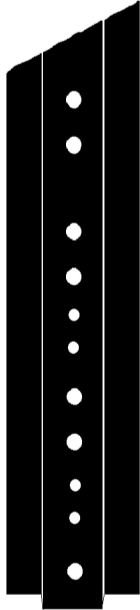
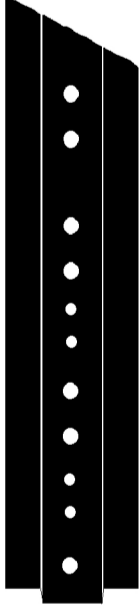
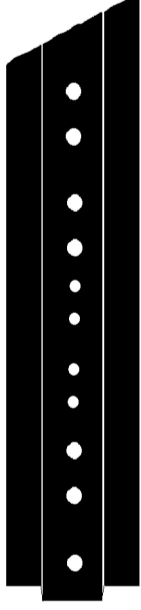
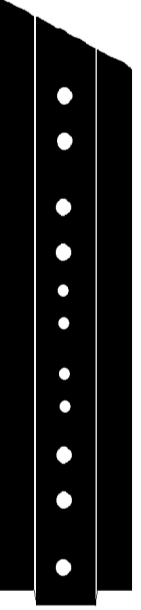
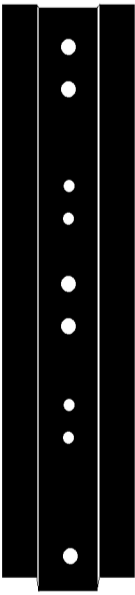
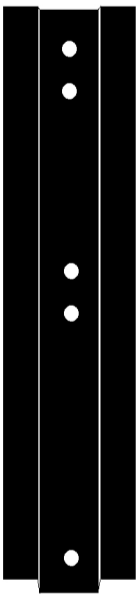
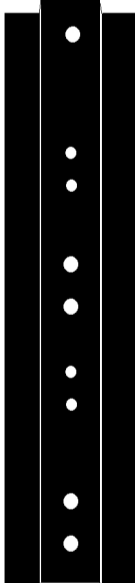
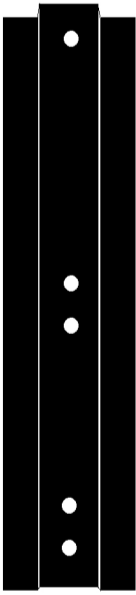
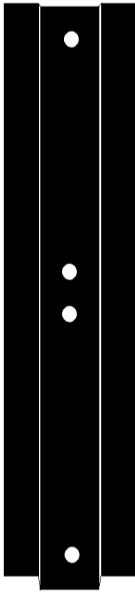
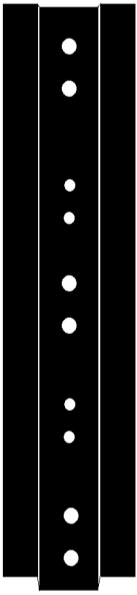
Poškození skleníku z důvodu nedostatečného ukotvení v zemi a nevhodného osazení není považováno za výrobní vadu a nelze jej reklamovat. Skleník musí být vždy ukotvený, nelze ho nechat volně položený na zemi!!!

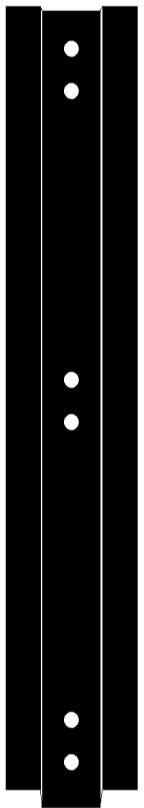
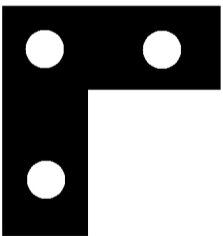
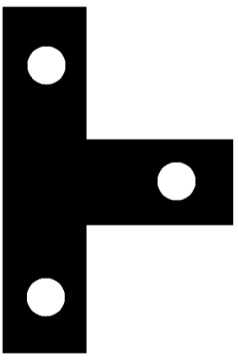
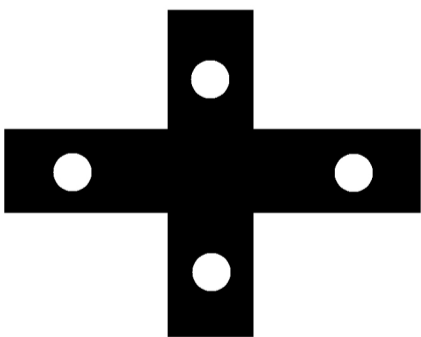
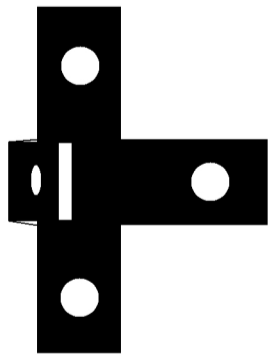
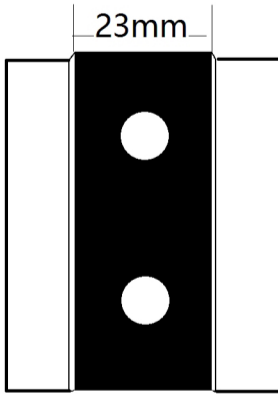
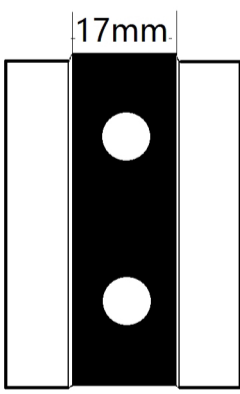
NO.1	NO.2	NO.3	NO.4	NO.5	NO.6
					
1020MM 4KS	1030MM 2KS	1010MM 15KS	1080MM 4KS	1050MM 4KS	515MM 4KS
NO.7	NO.8	NO.9	NO.9a	NO.10	NO.11
					
1000MM 1KS	1000MM 1KS	1030MM 2KS	1030MM 2KS	505MM 4KS	980MM 3KS

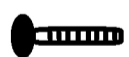
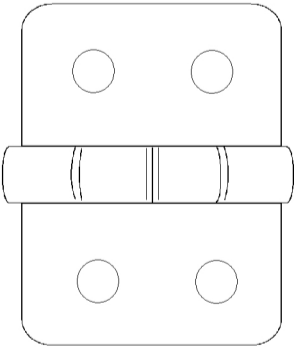
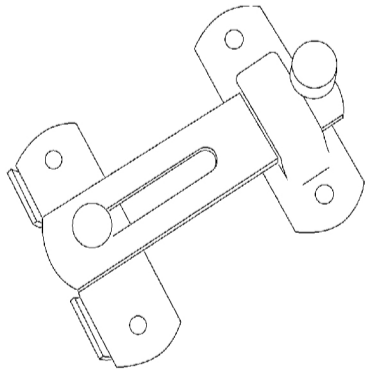
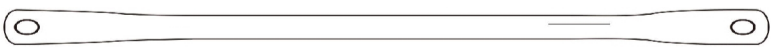
NO.12	NO.12a	NO.13	NO.14	NO.15	NO.16
					
785MM 12 KS	785MM 4KS	890MM 1KS	890MM 1KS	890MM 1KS	890MM 1KS
NO.17	NO.18	NO.19	NO.20	NO.21	NO.22
					
885MM 2KS	885MM 2KS	885MM 2KS	885MM 2KS	415MM 10KS	730MM 2KS

NO.23	A x20KS	B x20KS	C x12KS
 <p data-bbox="103 1153 263 1265">730MM 2KS</p>			
	D x8KS	E x88KS	F x76KS
		 <p data-bbox="805 907 917 952">23mm</p>	 <p data-bbox="1276 907 1380 952">17mm</p>
G x448KS	H x56KS	I x12KS	J x2KS
			
K x8KS		L x4KS	
			

1035x1010mm

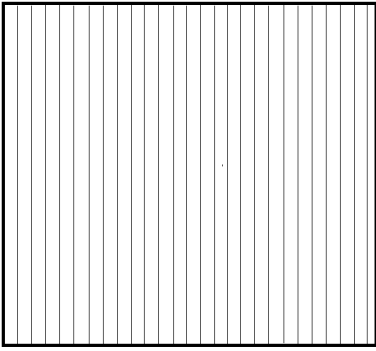

X 6KS

410x840mm

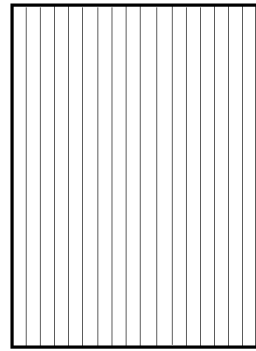

X 4KS

765x1010mm

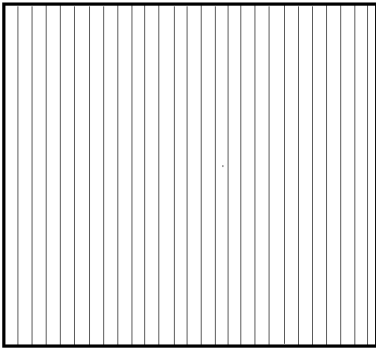

X 12KS

410x660mm

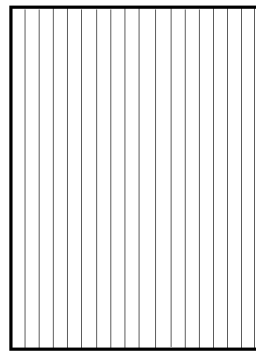

X 2KS

505x1015mm

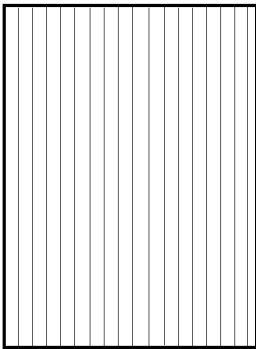

X 4KS

505x870mm

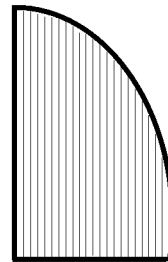

X 2KS

505x870mm

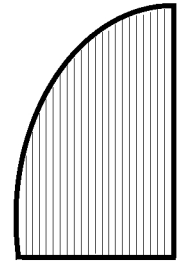

X 2KS

980x1015mm

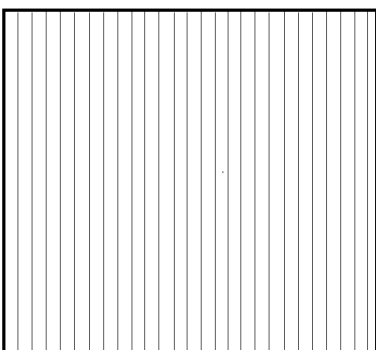





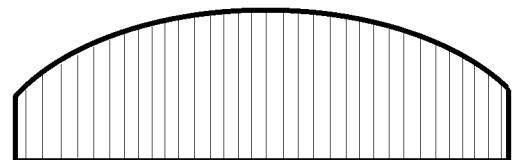

X 1KS

980x240mm

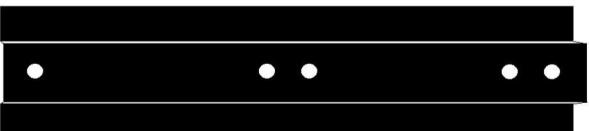

X 2KS

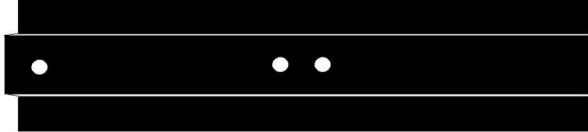
KROK 1

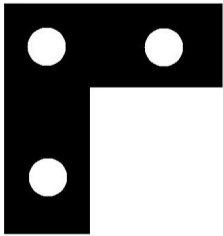
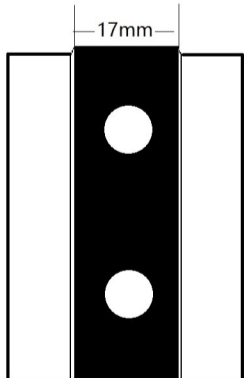
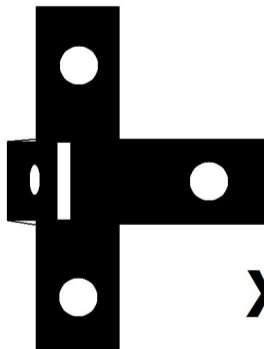
ČÍSLO DÍLU	OBRÁZEK		POČET
1			4
2			2
4		dolů 	4
6			4
7			1
8			1
A	 x4		
F	 x8	D	 x8

Před instalací polykarbonátových desek neutahujte šrouby.

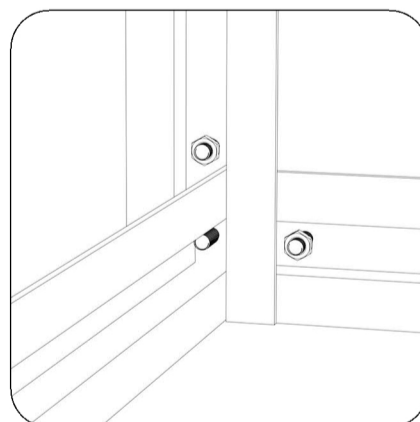
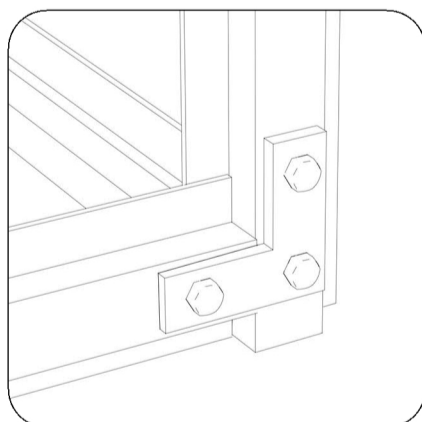
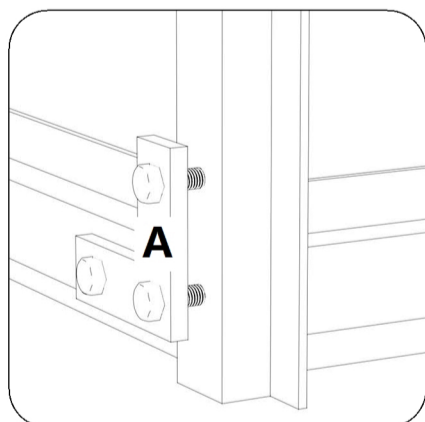
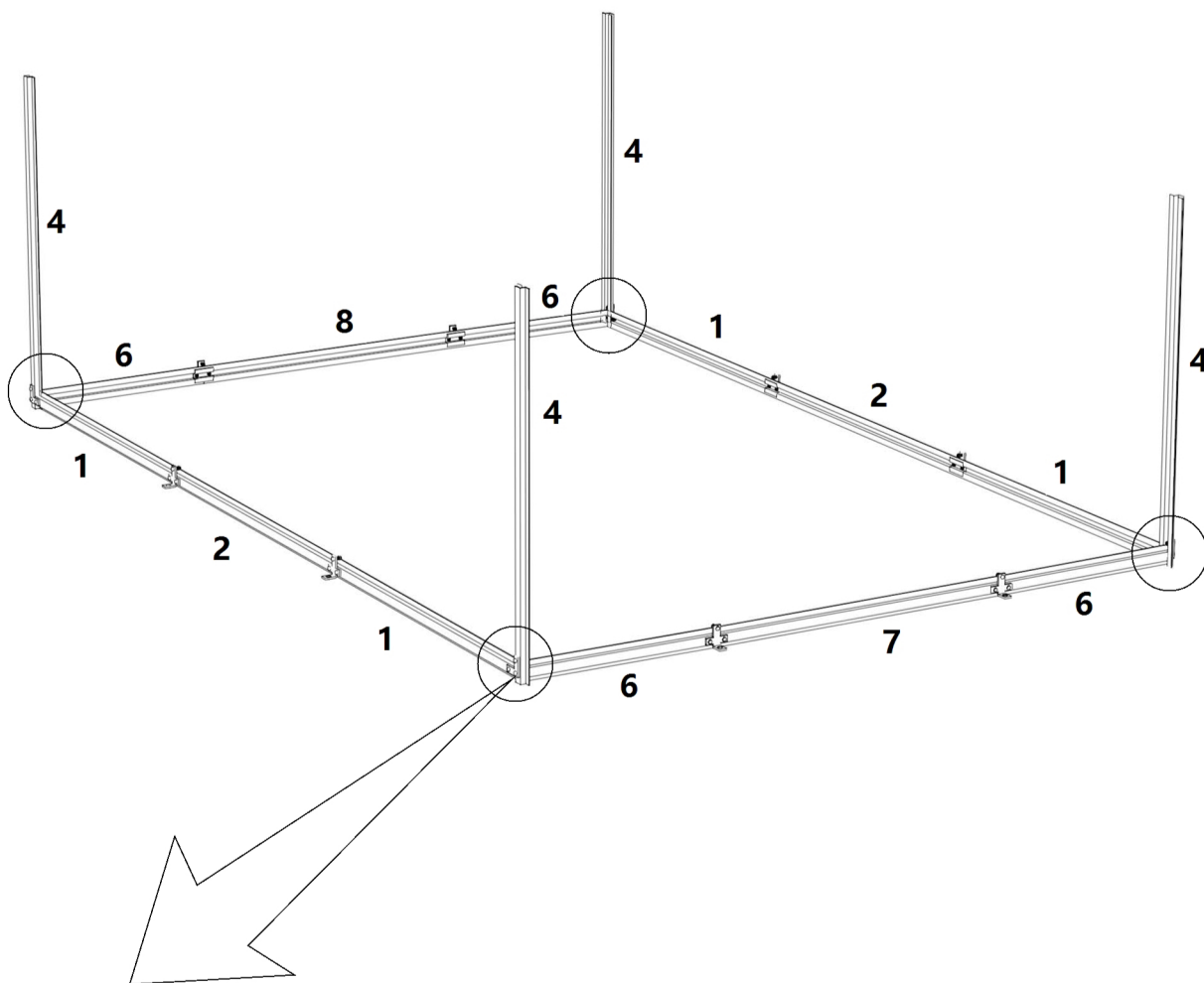

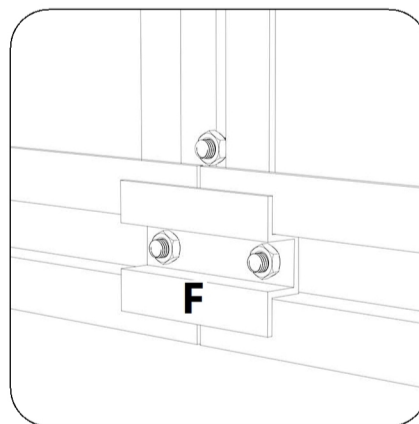
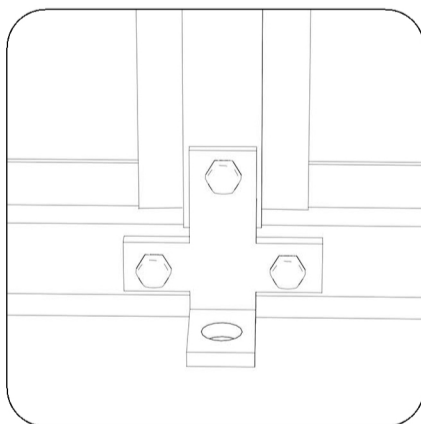
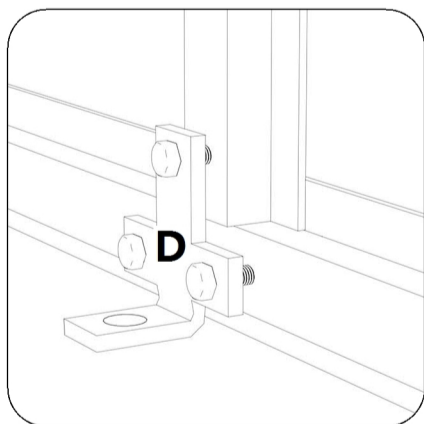
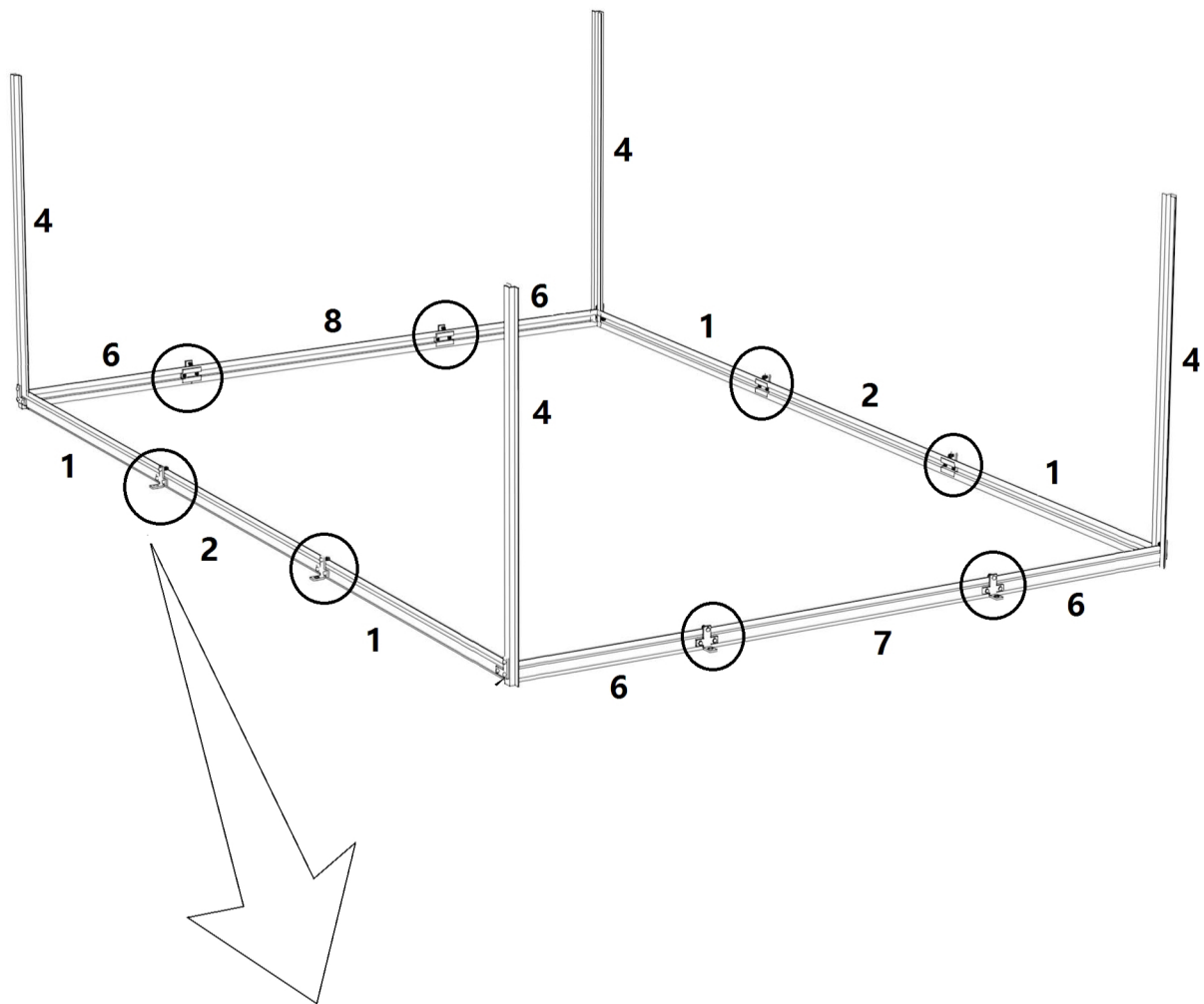

Před instalací polykarbonátových desek neutahujte šrouby.

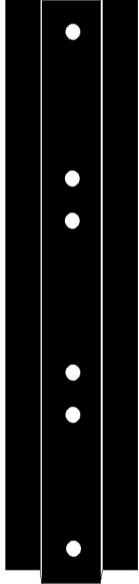
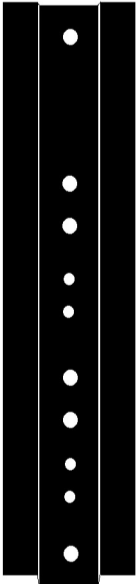
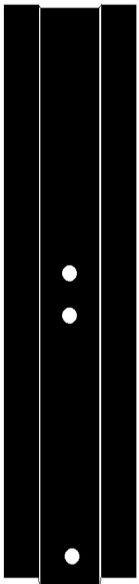
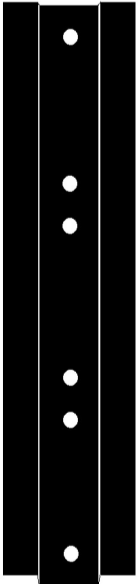

KROK 2

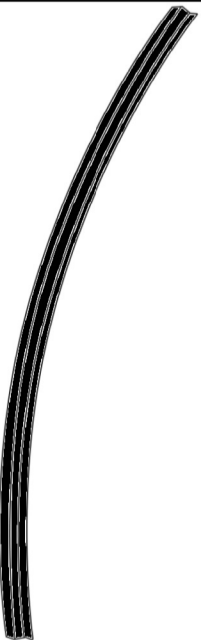
ČÍSLO DÍLU	9	9A	10	11
OBRÁZEK				
POČET	2	2	4	3

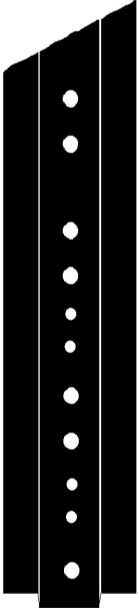
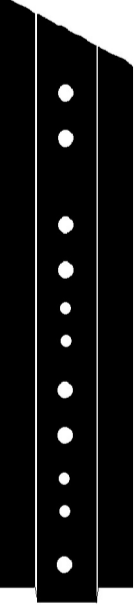
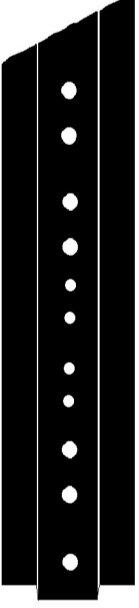
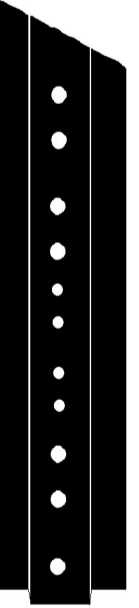
12	12A	13	14	15	16
					
4	4	1	1	1	1

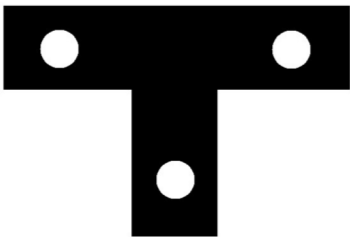
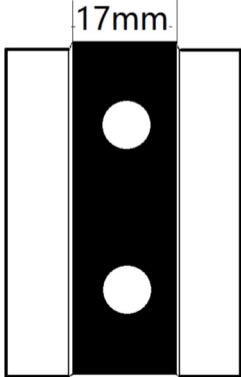
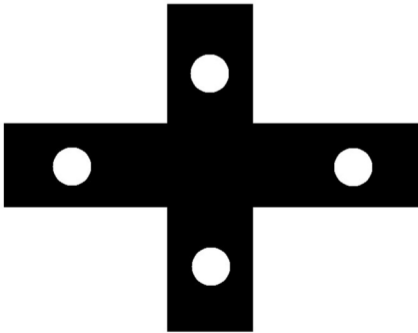

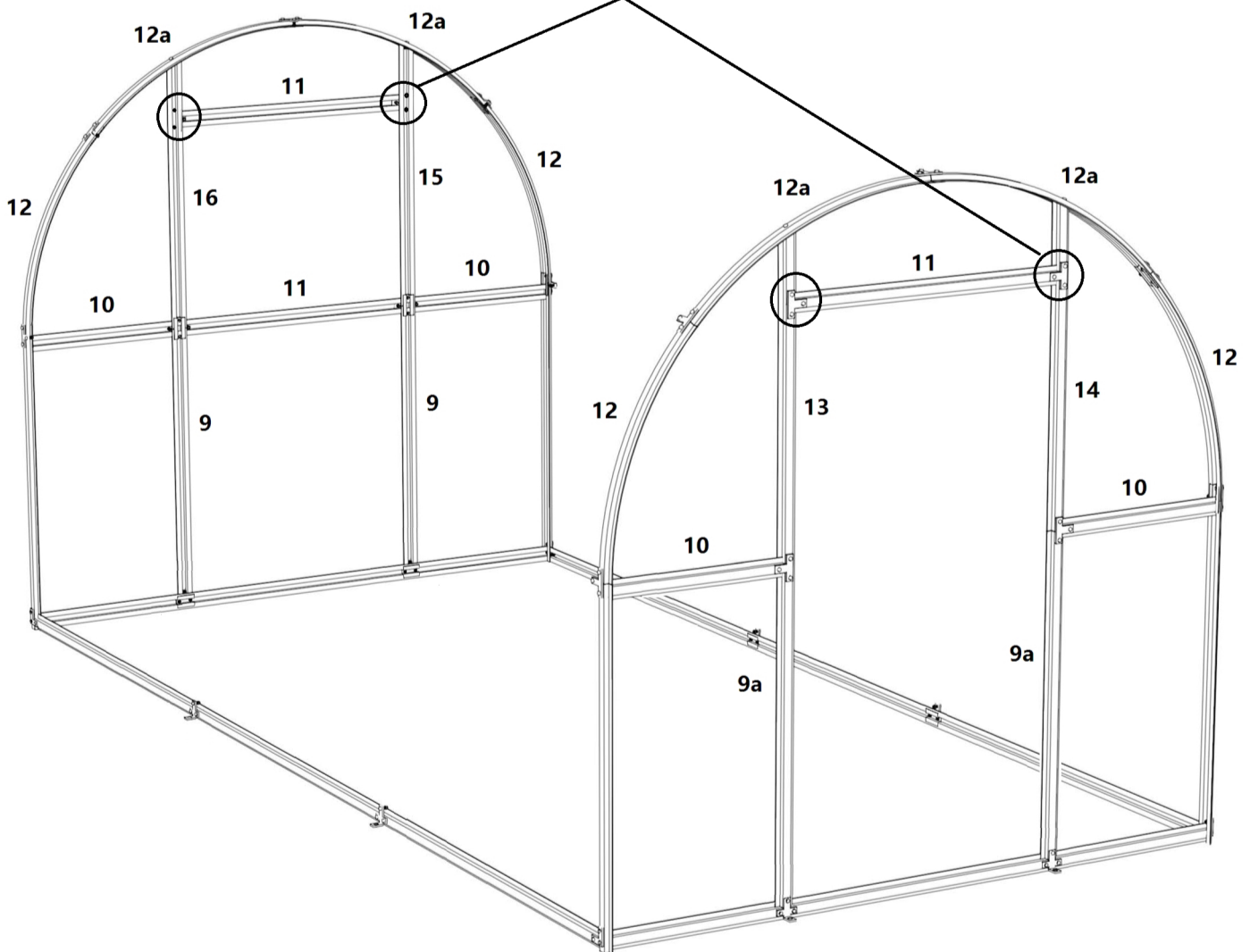
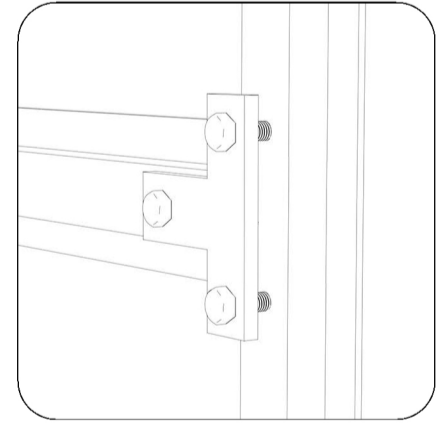
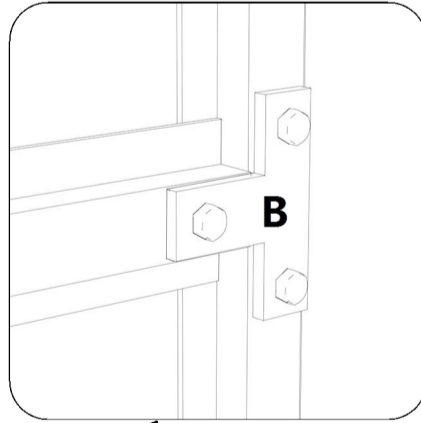
ČÍSLO DÍLU	OBRÁZEK	POČET
B		16
F		14
C		2

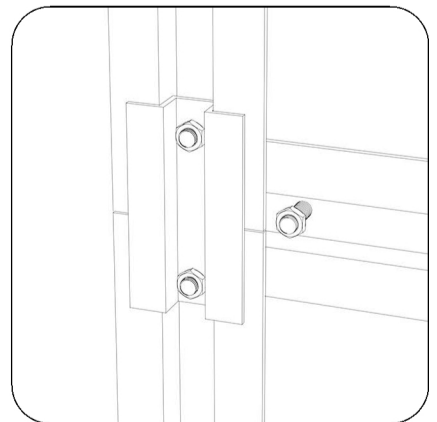
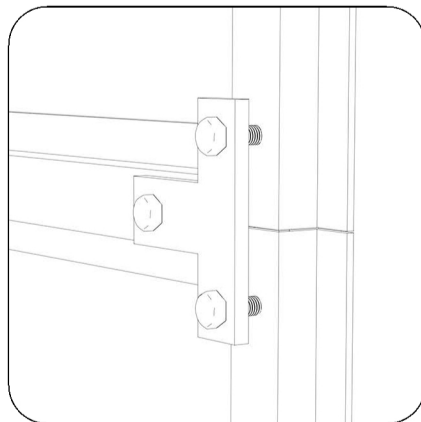
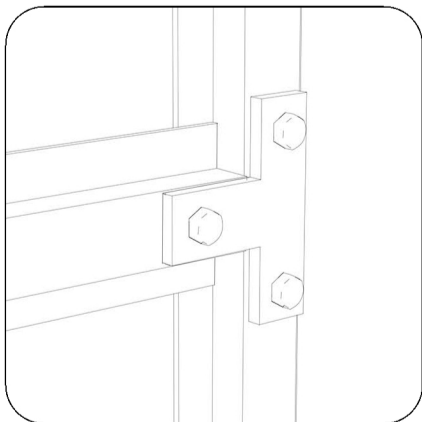
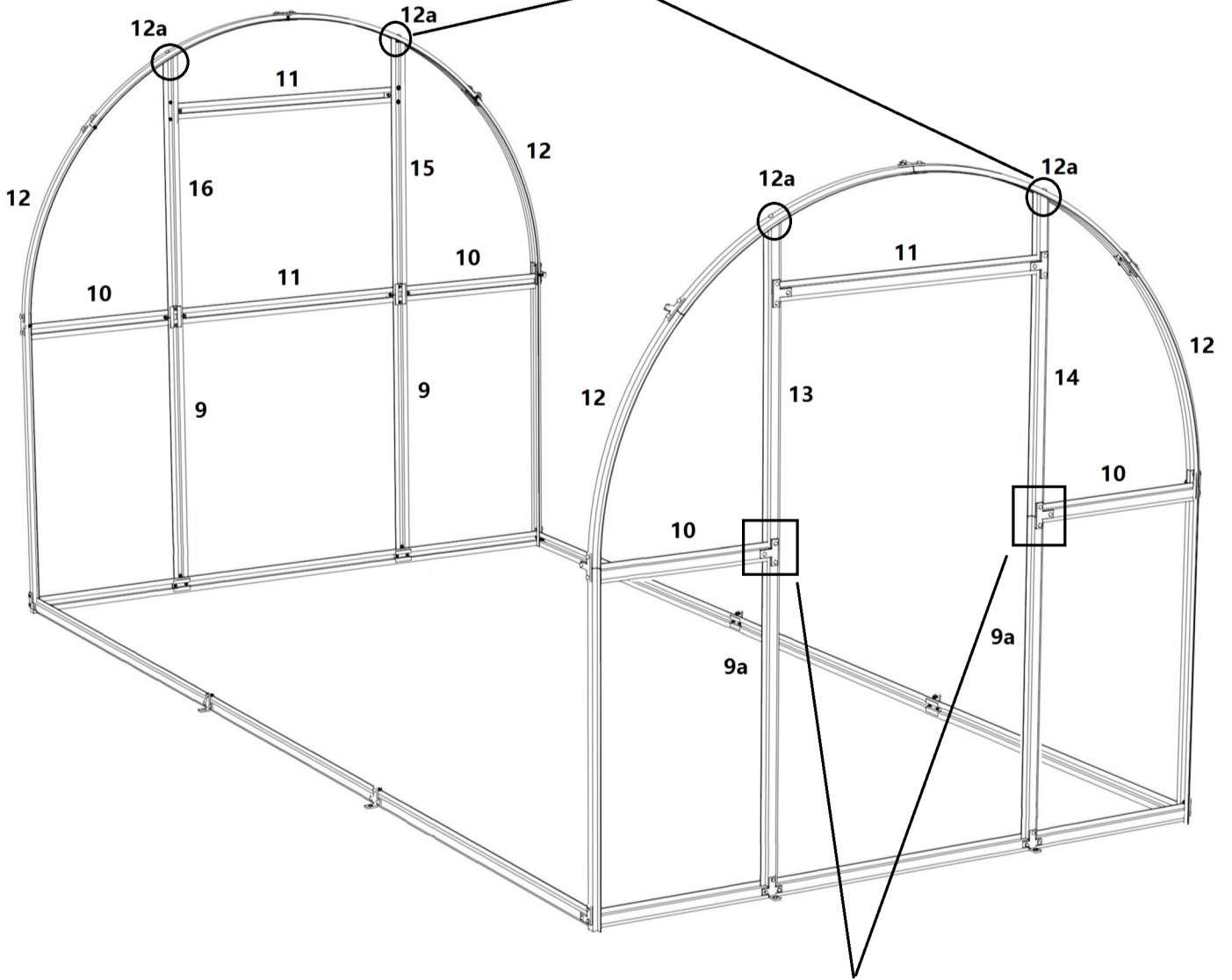
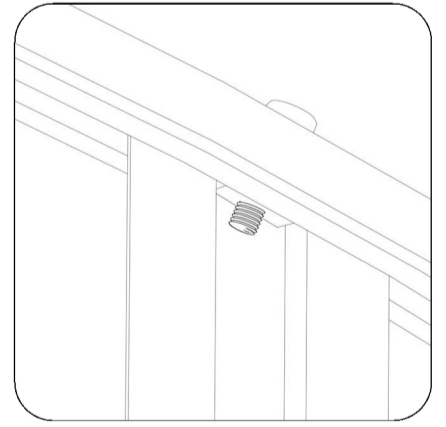
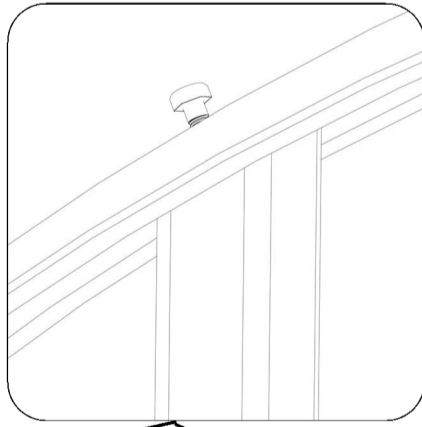

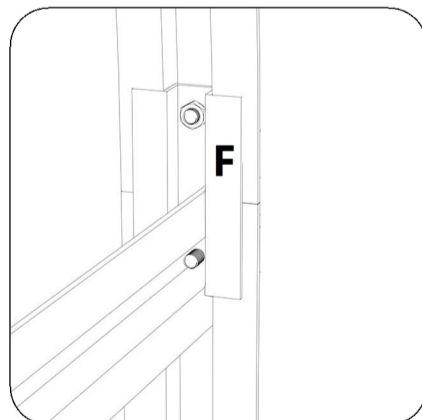
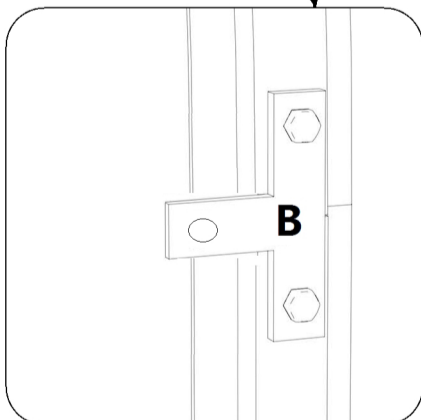
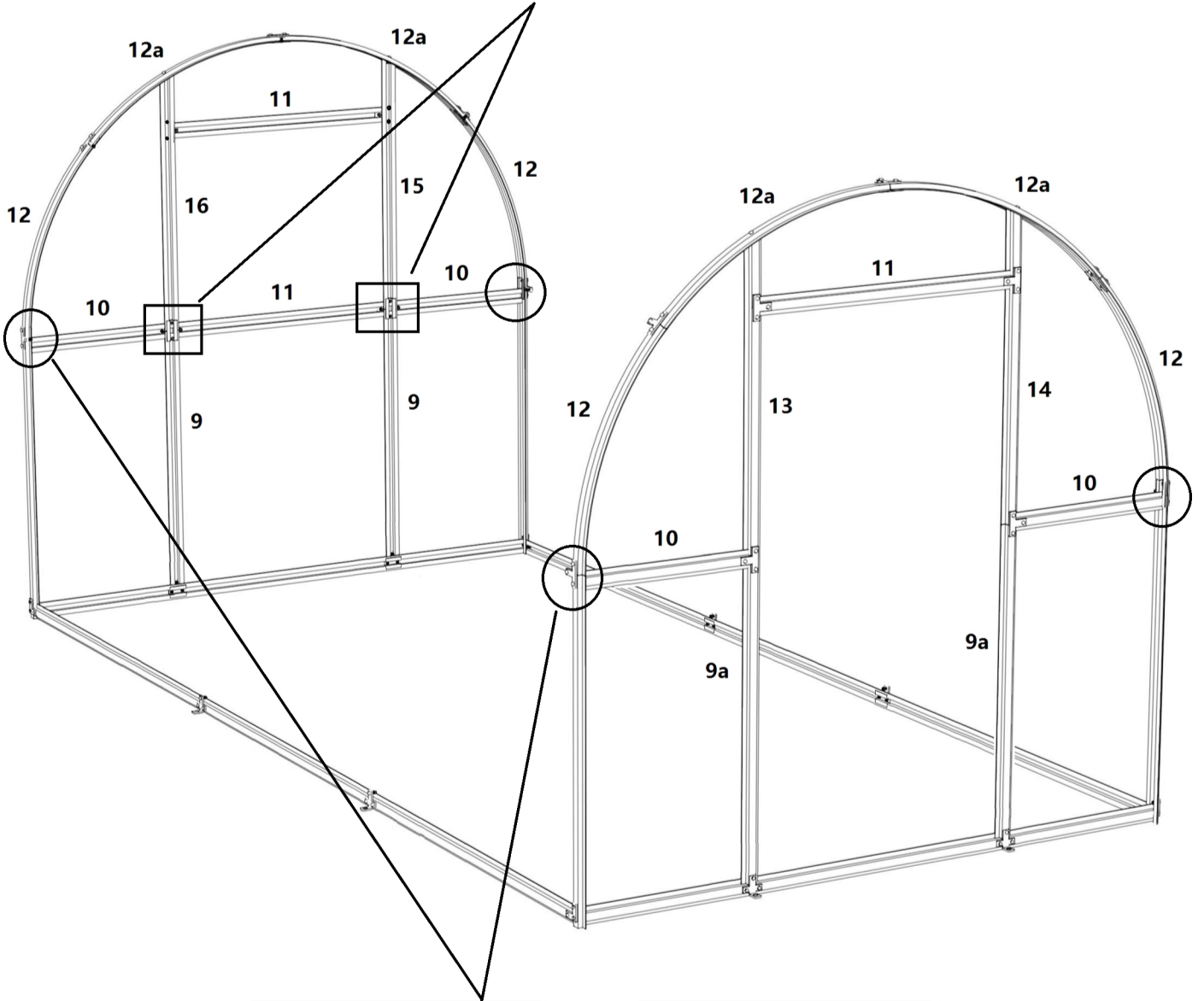
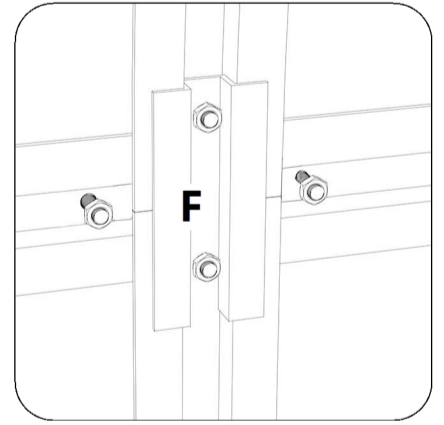
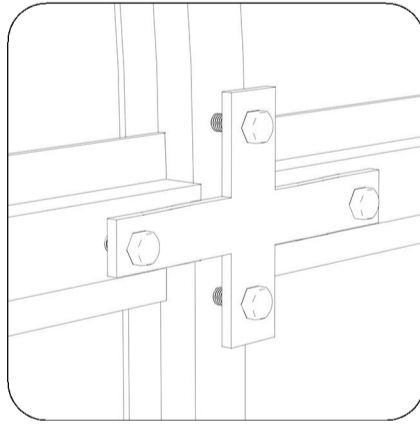
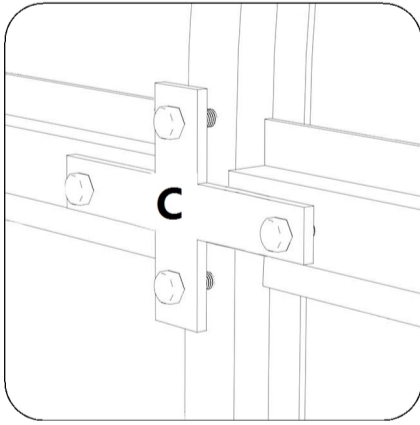



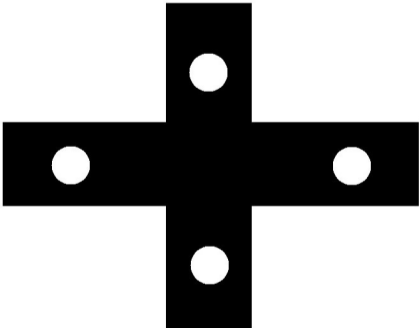
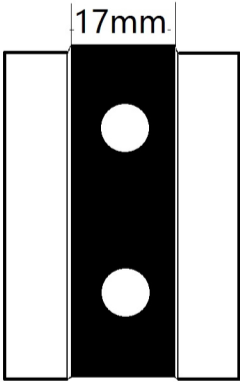

KROK 3

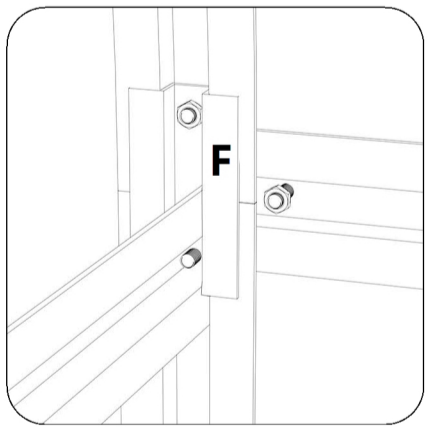
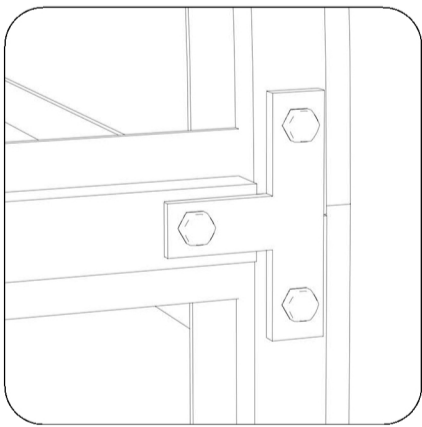
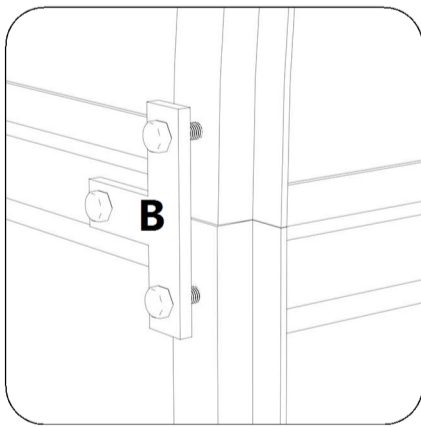
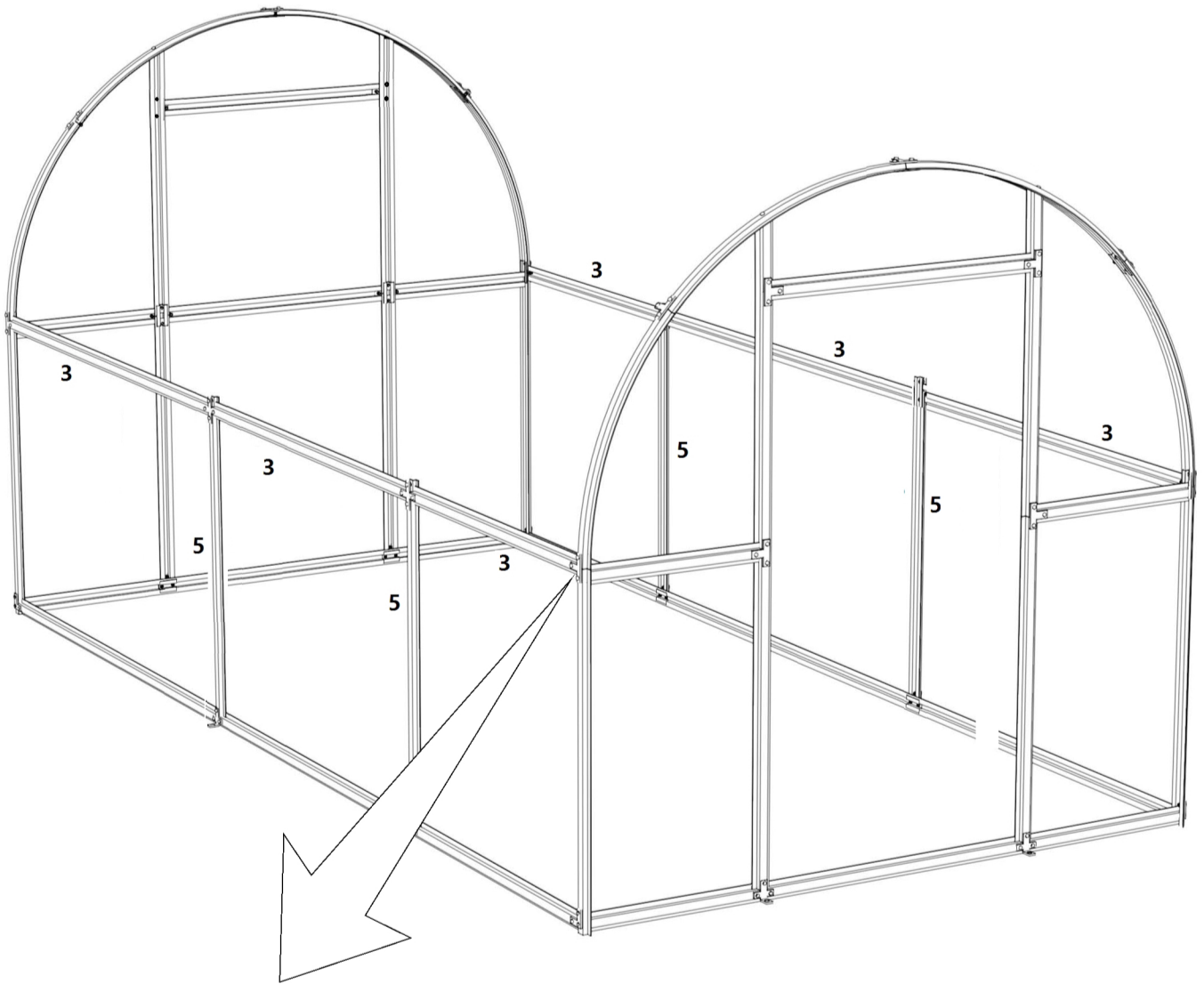
ČÍSLO DÍLU	OBRÁZEK	POČET
3		6
5		4
C		4
F		4

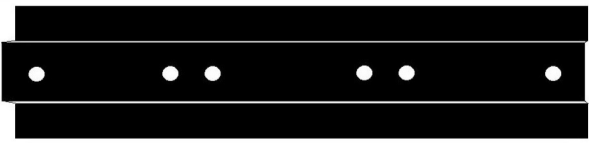

KROK 4

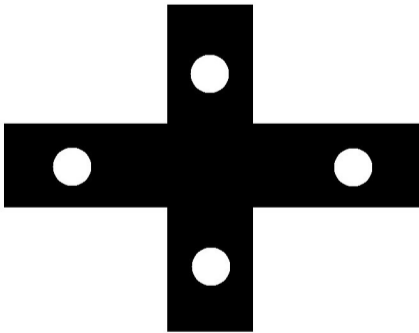
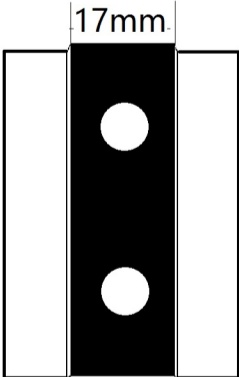
ČÍSLO DÍLU	OBRÁZEK	POČET
3		9
12		8
C		6
F		6

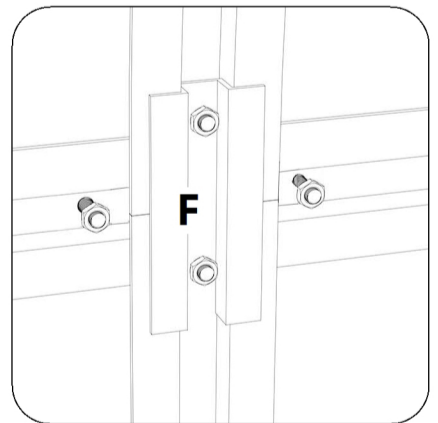
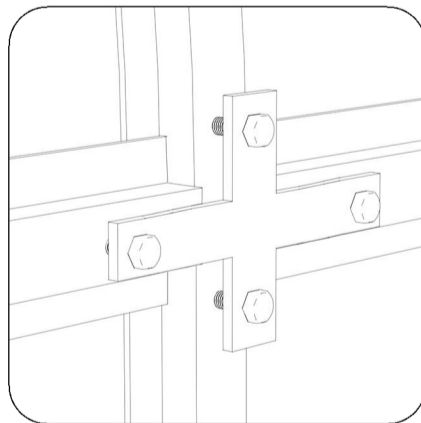
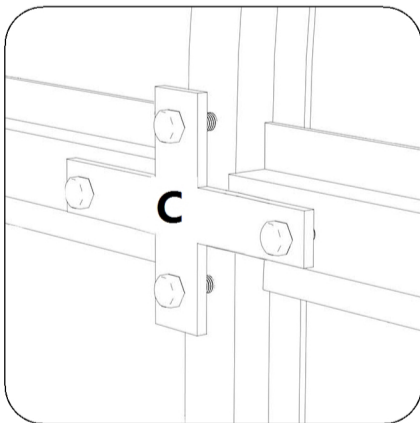
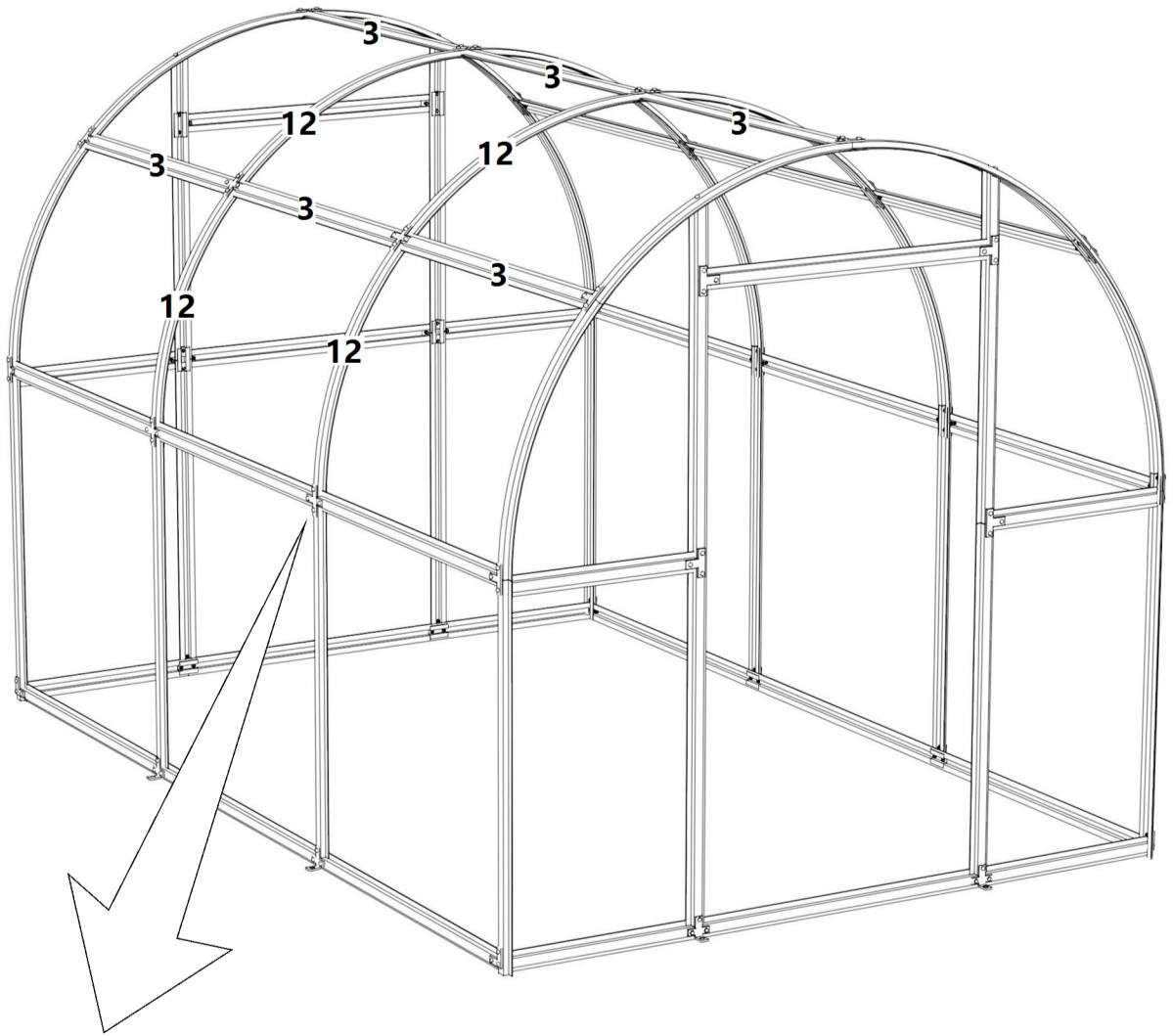

KROK 5

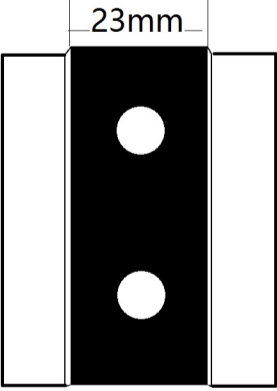
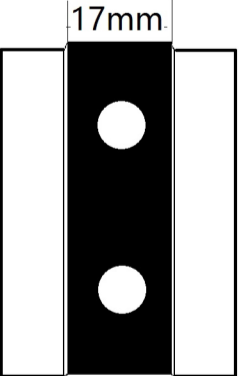
ČÍSLO DÍLU	OBRÁZEK	POČET
E		44
F		30

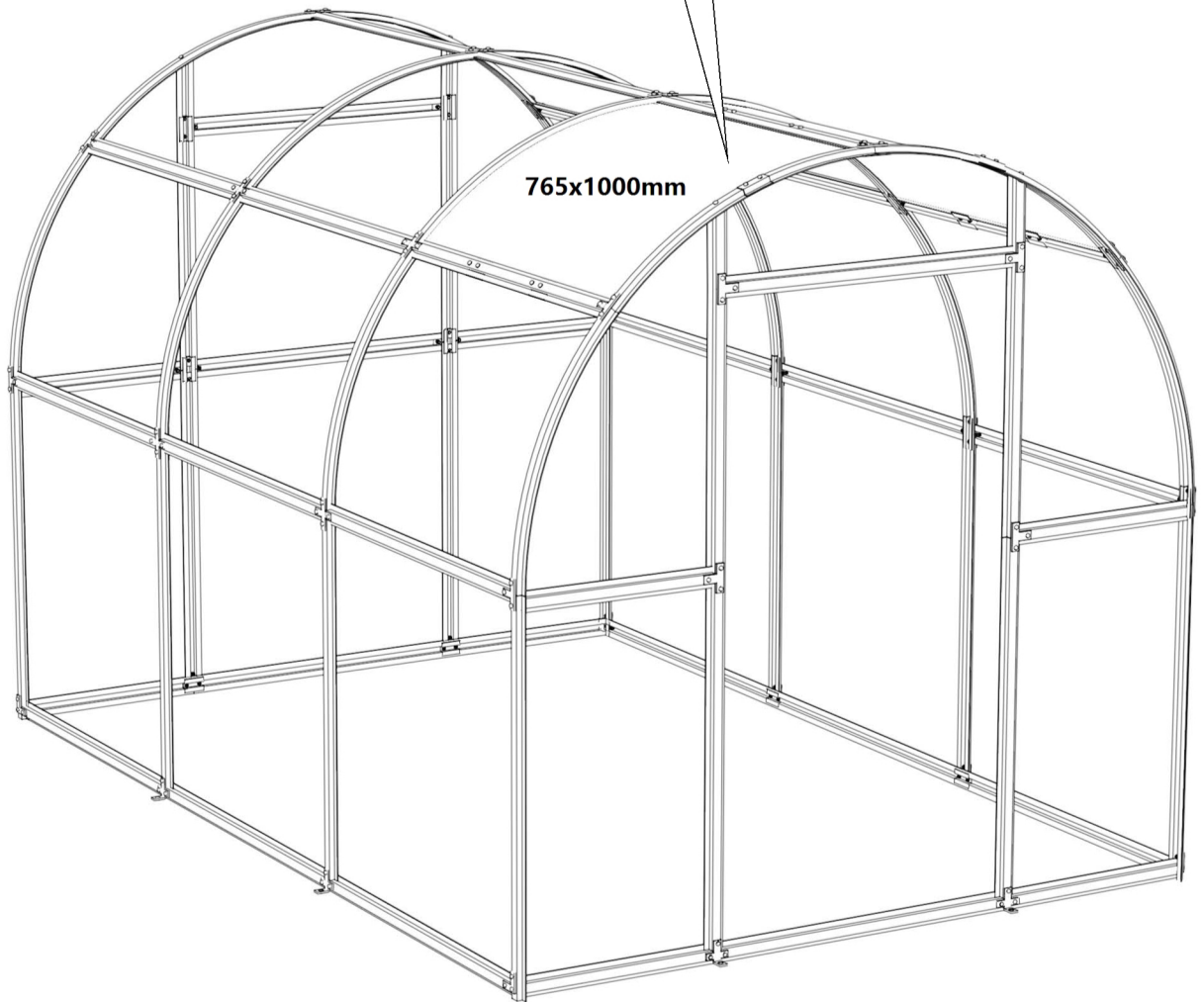
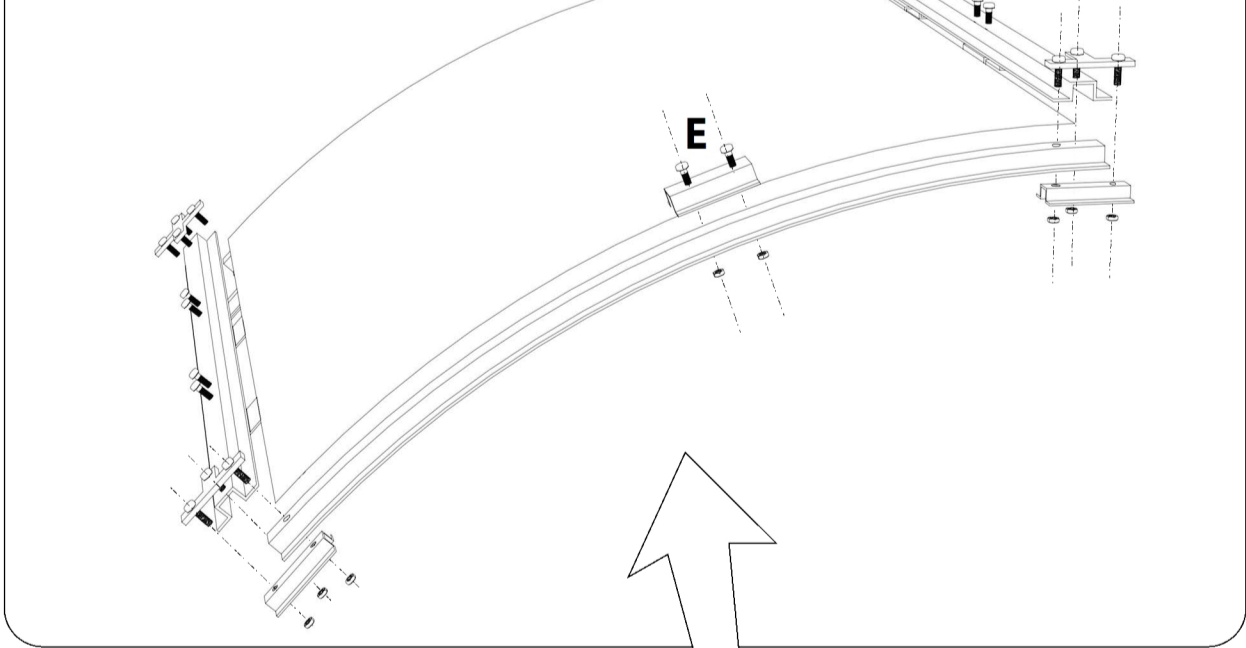

Zatlačte horní/spodní část pod profil č. 3. Přiložte spojovací profil F na vnitřní stranu profilu č. 3, zvnějšku profilu protáhněte šrouby skrze profil č. 3 a spojte se spojovacím profilem. Obě strany polykarbonátové desky se přiloží na horní hranu profilů č. 12-12a a přichytí spojovacím profilem E. Stejným způsobem se polykarbonátové desky přichytávají i u profilů č. 1 a č. 2, kde se rovněž přikládají na profil a přichytávají ke konstrukci pomocí spojovacího profilu E. Poté, co jsou všechny boční polykarbonátové desky umístěné do profilů, dotáhněte šrouby.

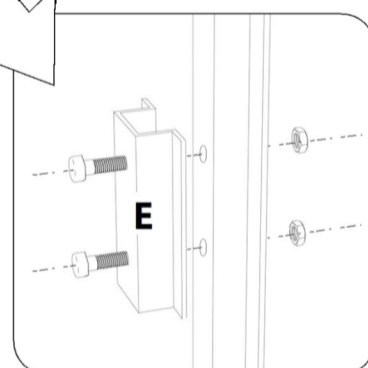
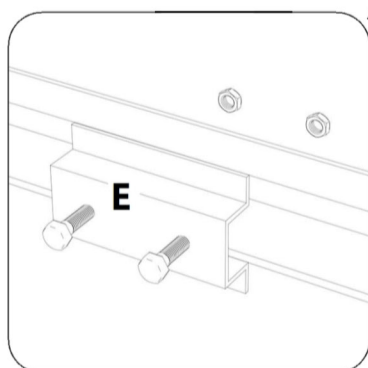
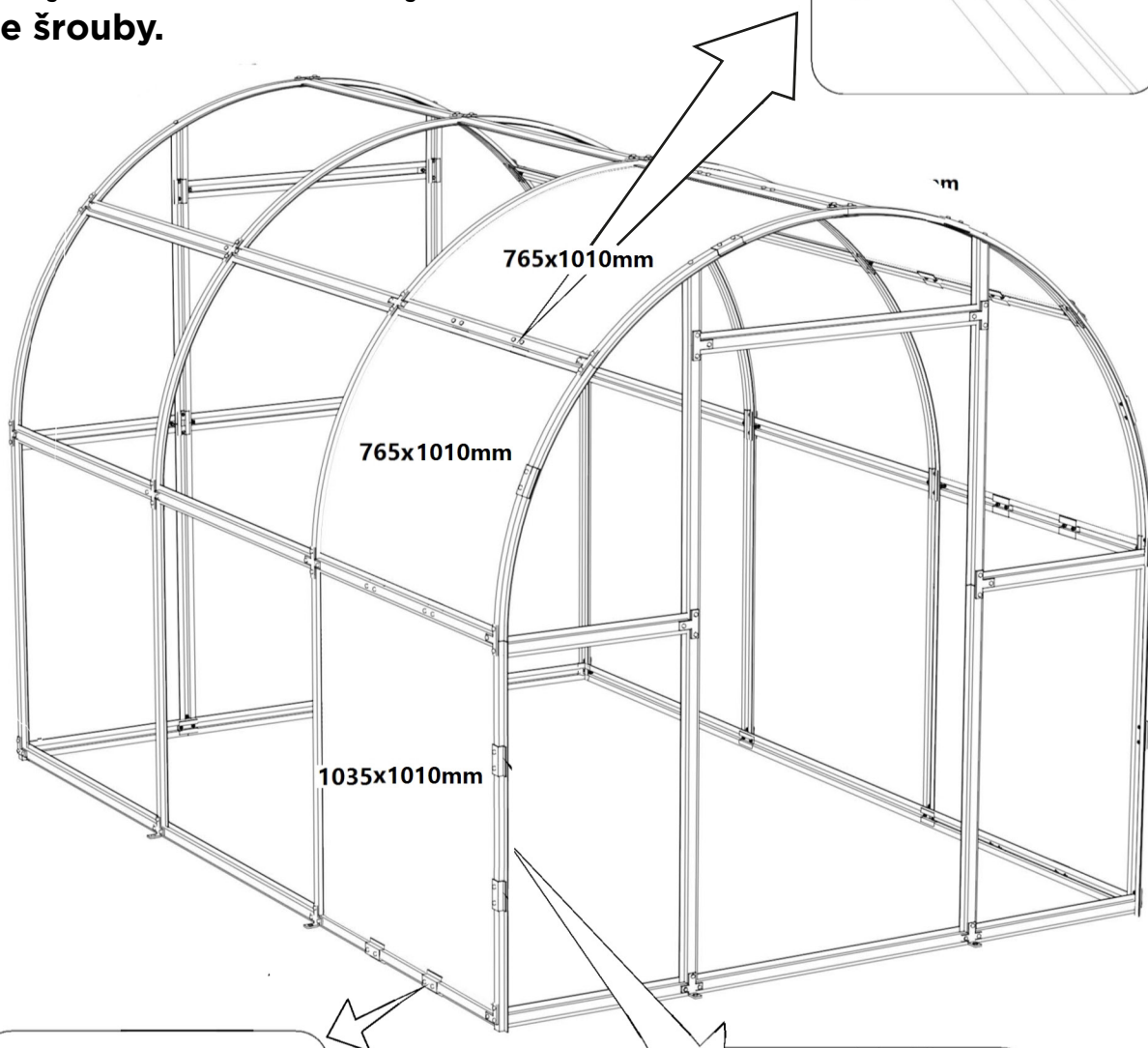
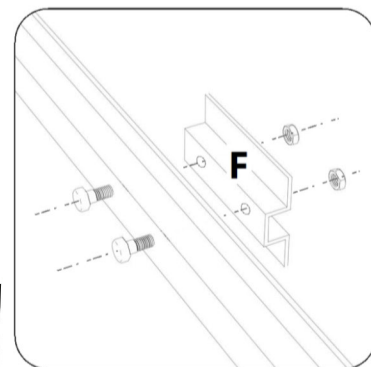

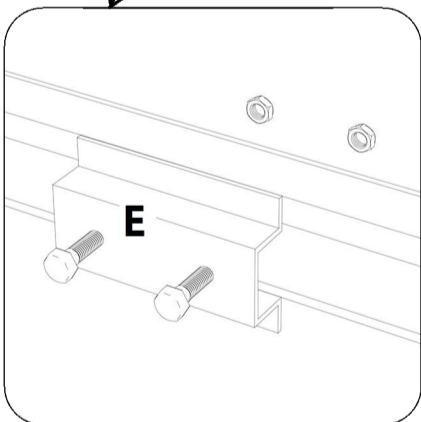
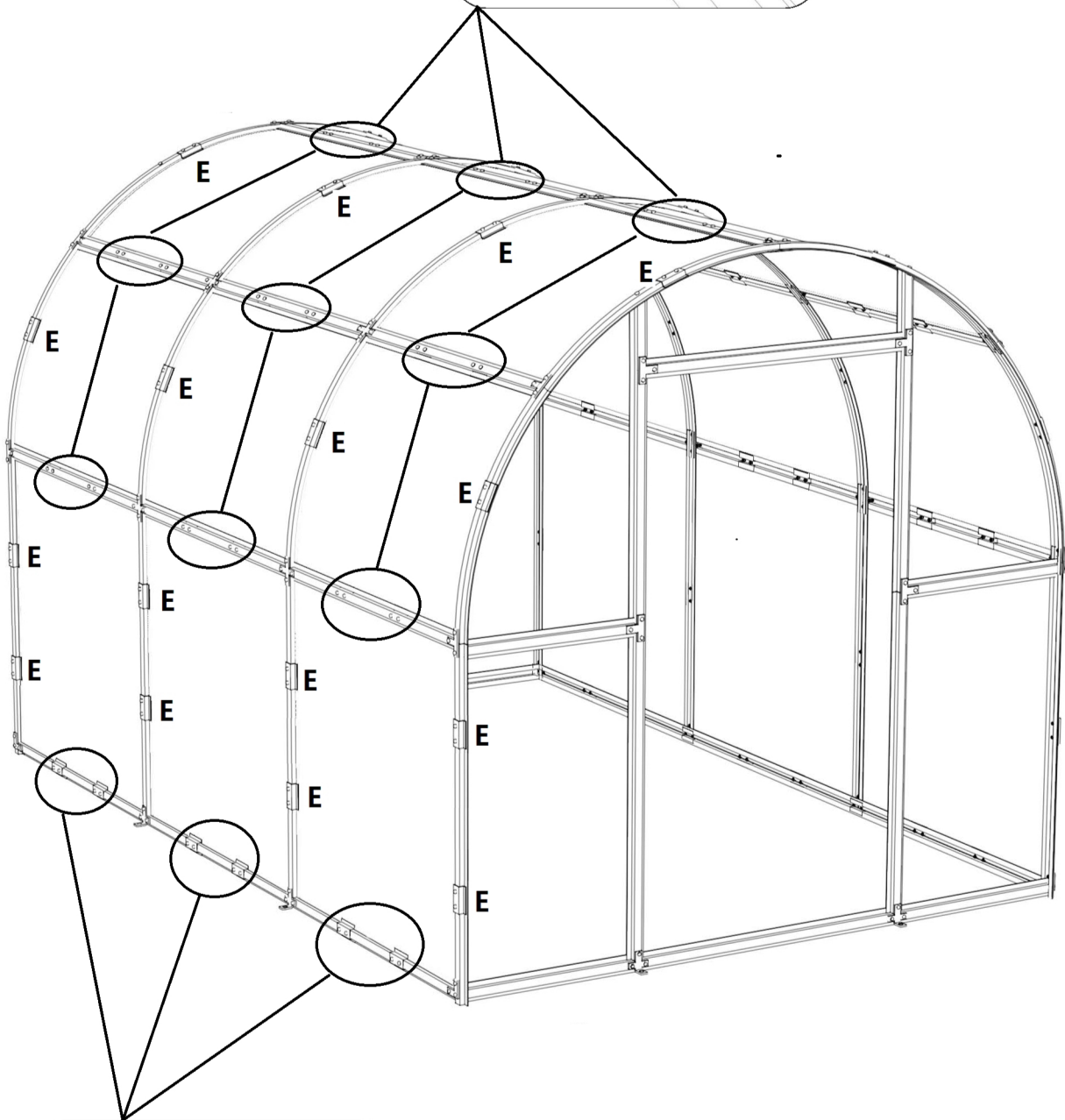
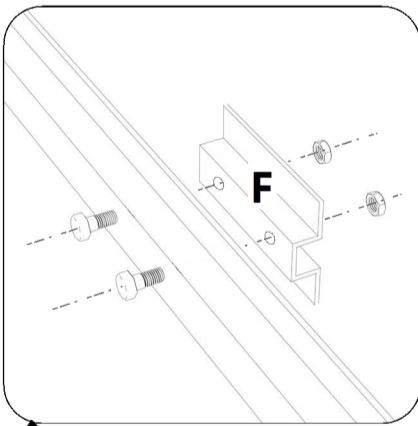

KROK 6

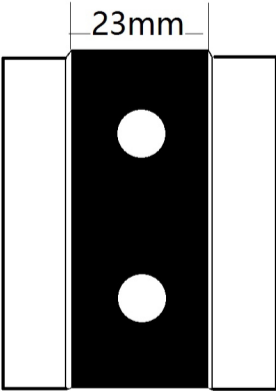
ČÍSLO DÍLU	OBRÁZEK	POČET
E	 <p>The drawing shows a vertical rectangular component. The central portion is black and contains two white circles, one above the other. This central portion is flanked by two white rectangular sections. A dimension line above the black section indicates a width of 23mm.</p>	32

Přední část

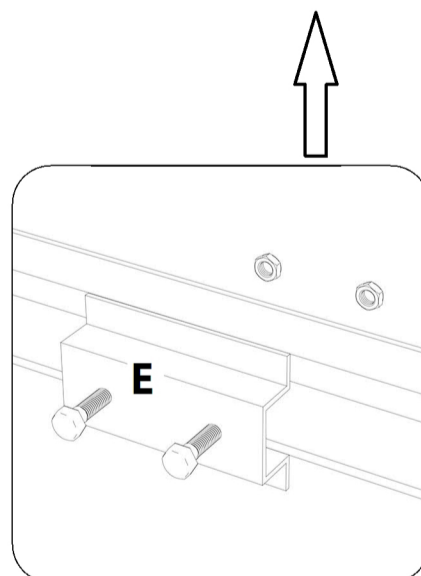
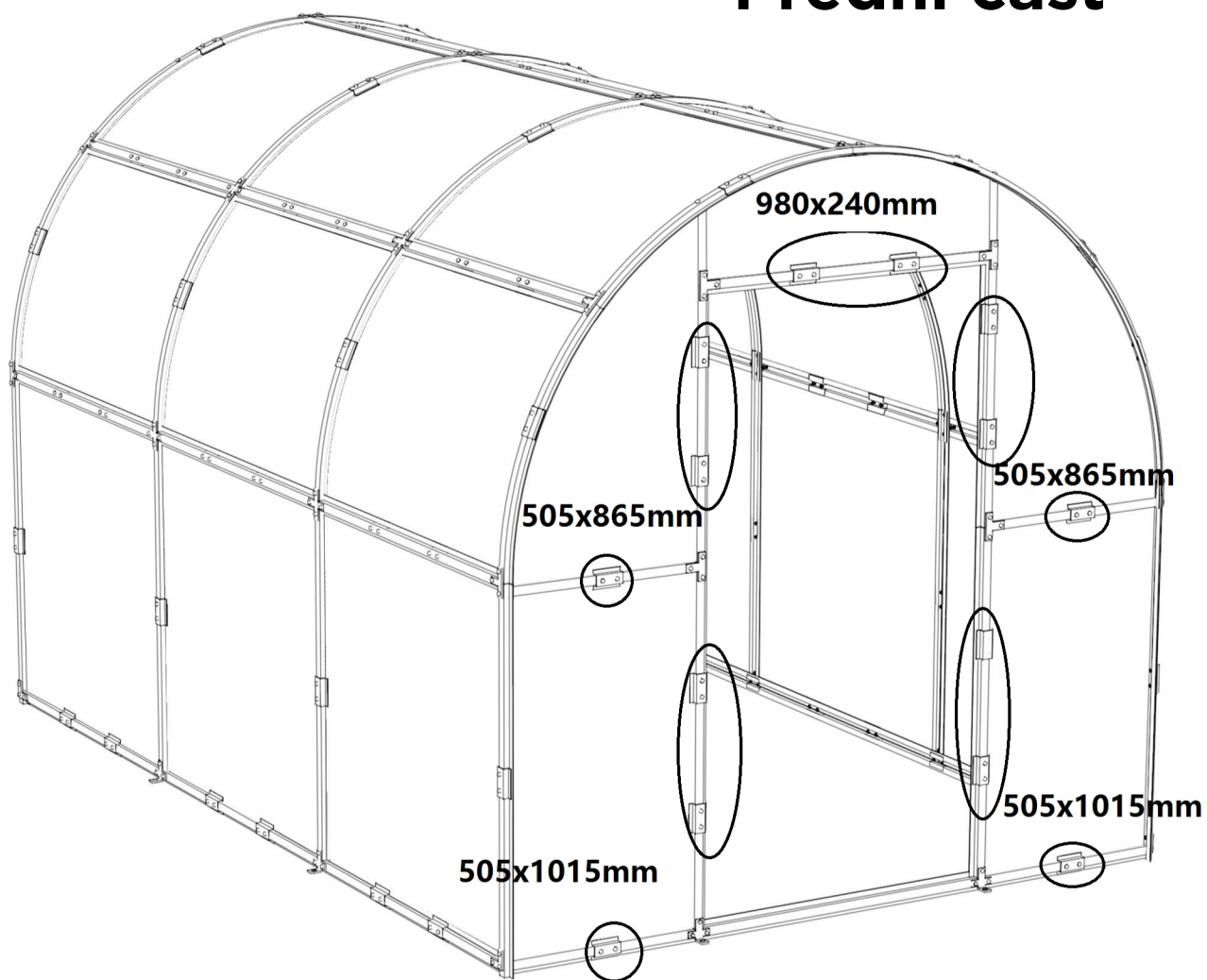

Zadní část

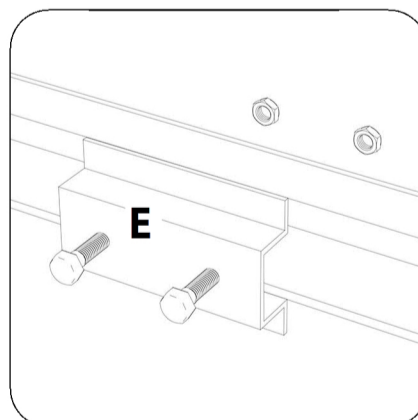
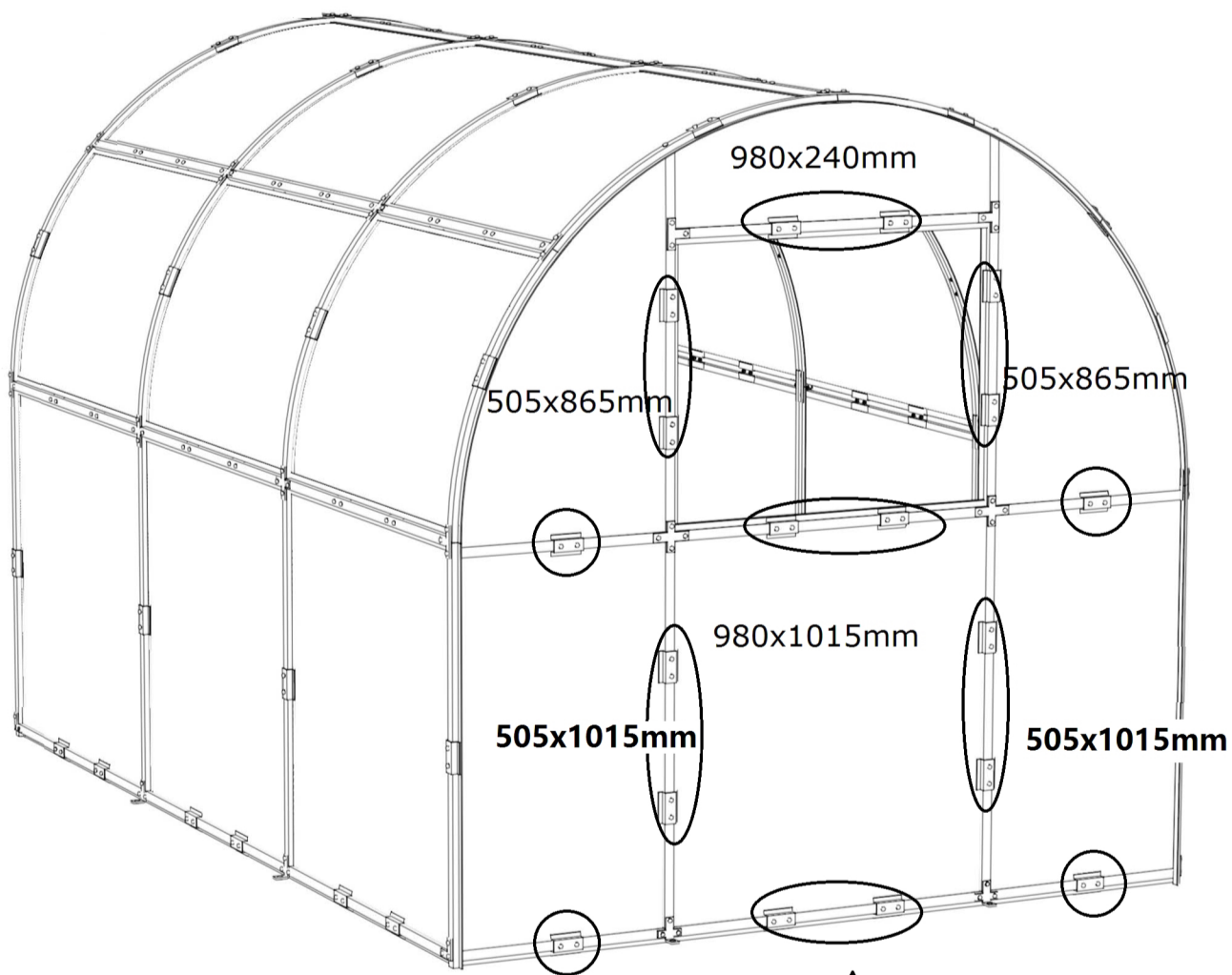

KROK 7

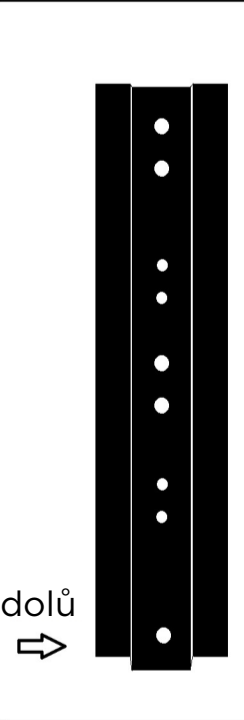
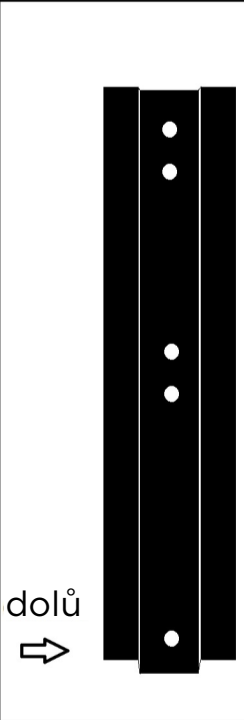
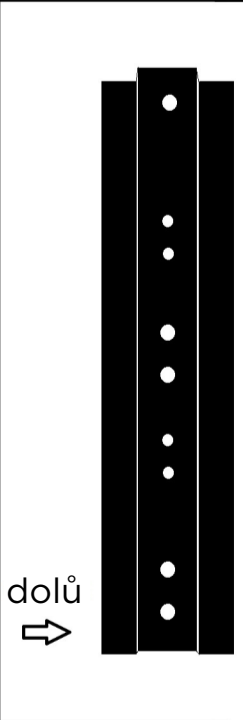
ČÍSLO DÍLU	17	18	19
OBRÁZEK			
POČET	2	2	2

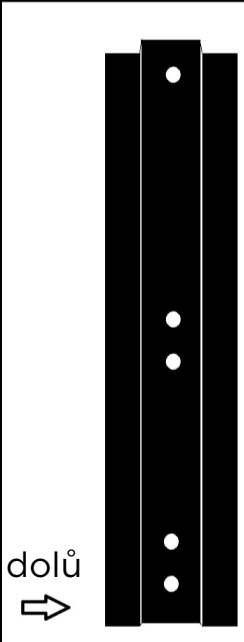
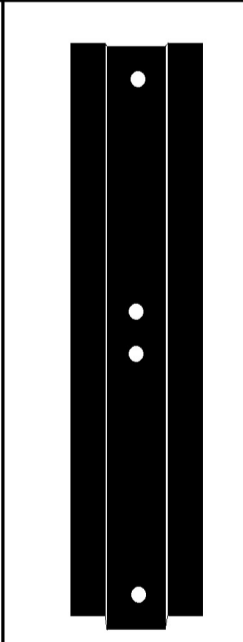
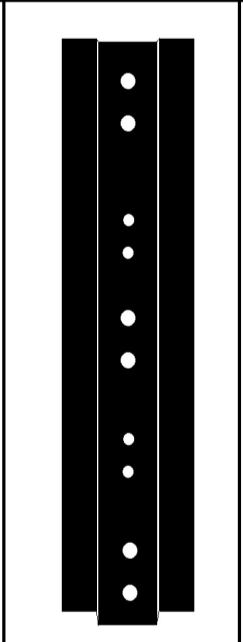
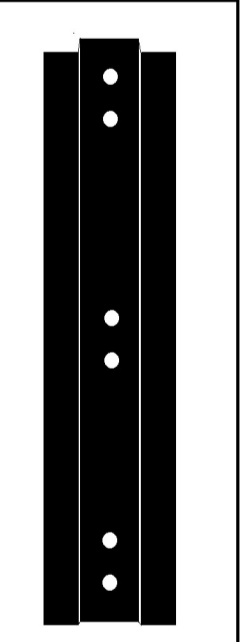
	20	21	22	23
				
	2	10	2	2

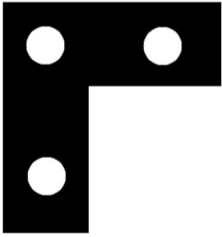
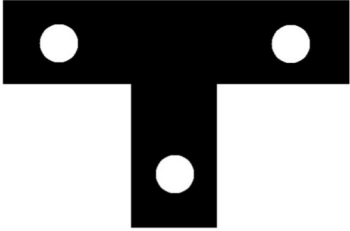
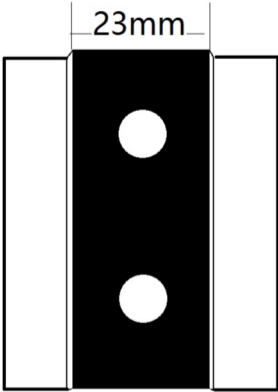
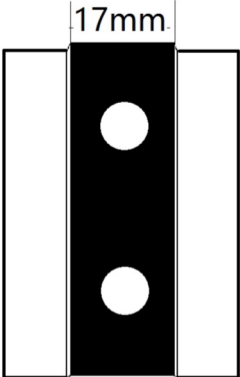
ČÍSLO DÍLU	OBRÁZEK	POČET
A		16
B		4
E		12
F		14

DVEŘE

přední strana

zadní strana

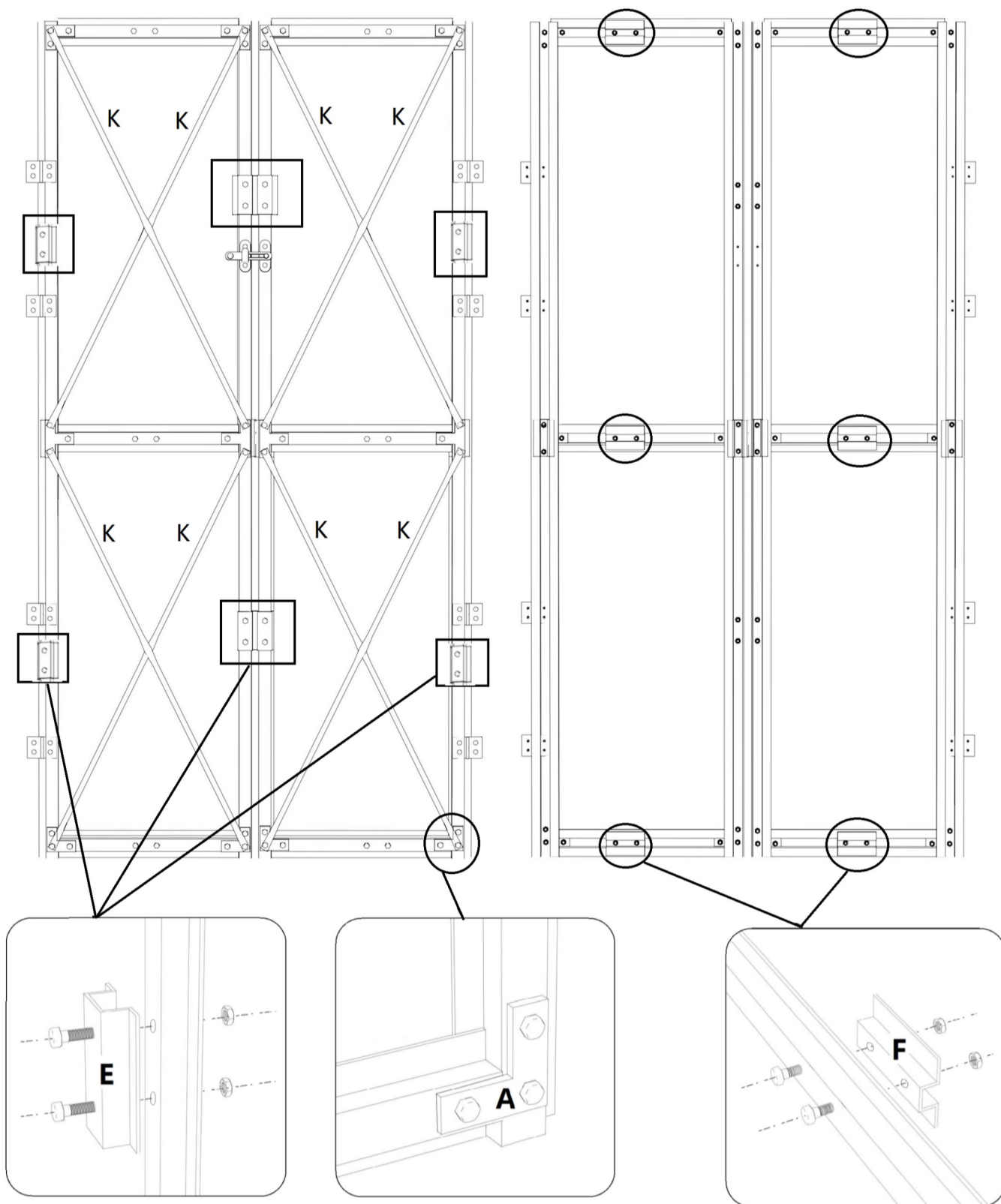

Zatlačte horní a spodní strany polykarbonátové desky pod profil č. 21, přiložte z vnitřní strany spojovací profil F a zajistěte šrouby. Zbylé dvě strany polykarbonátové desky přiložte na horní hranu profilů č 17-20 a zajistěte spojovacími profily E. Následně všechny šrouby dotáhněte.

Připevněte panty a madla

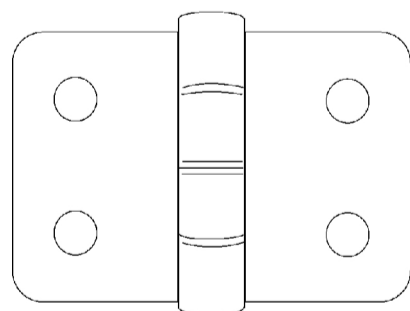
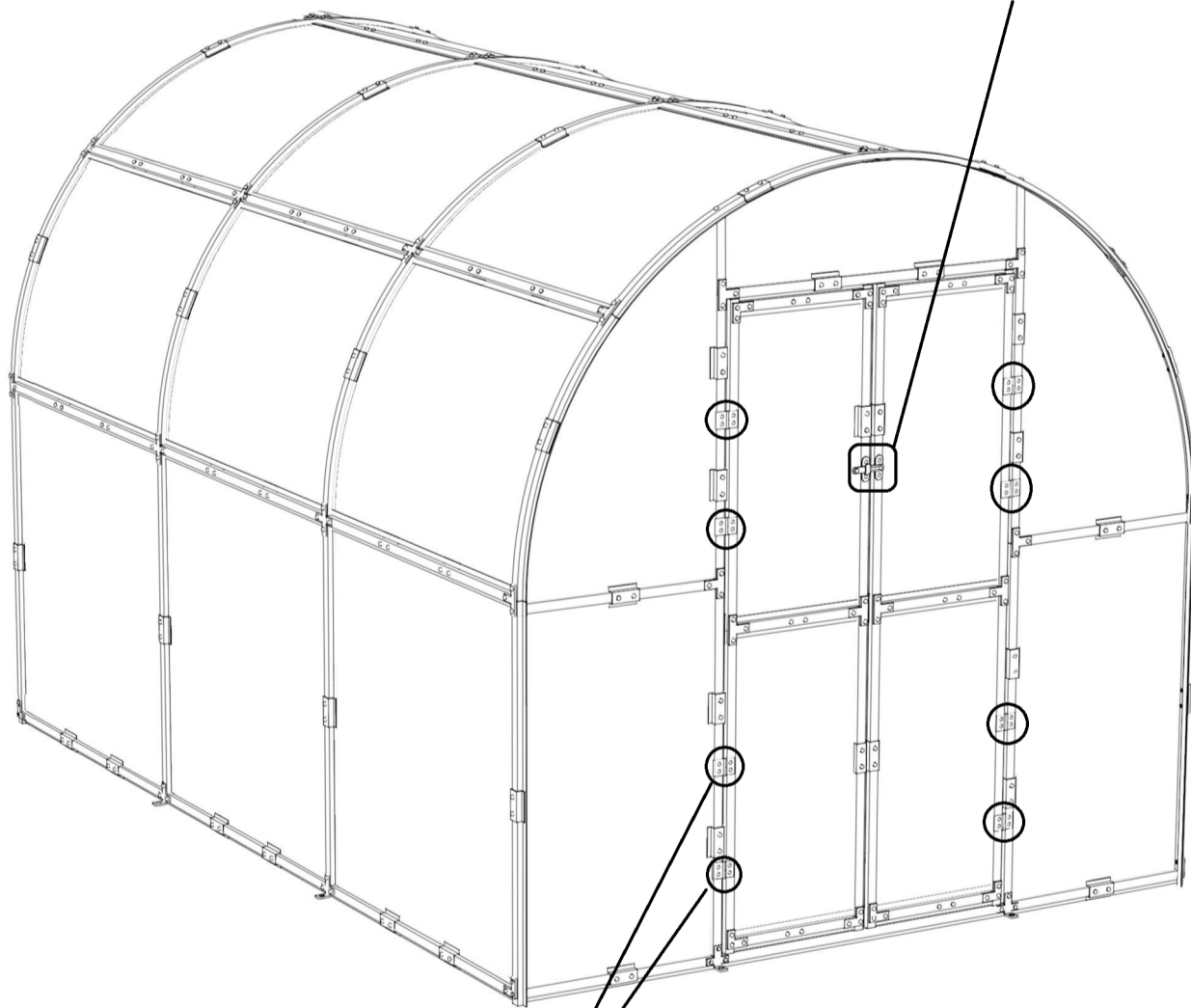
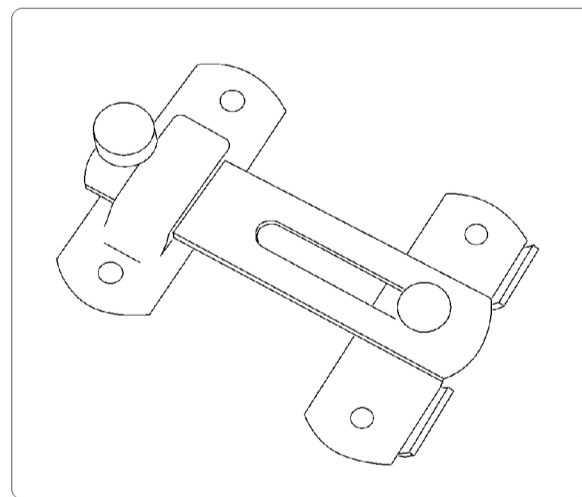

OKNA

Zatlačte horní a spodní strany polykarbonátové desky pod profil č. 21, přiložte z vnitřní strany spojovací profil F a zajistěte šrouby. Zbylé dvě strany polykarbonátové desky přiložte na horní hranu profilů č 22-23 a zajistěte spojovacími profily E. Následně všechny šrouby dotáhněte.

přední strana

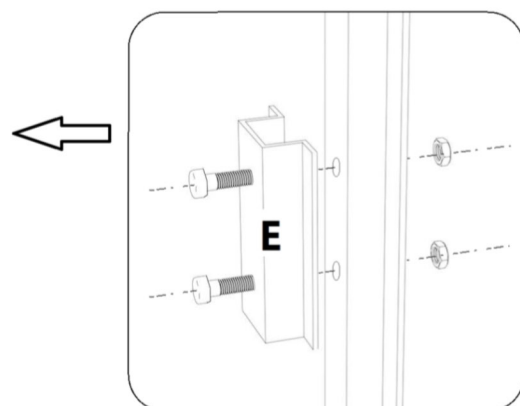
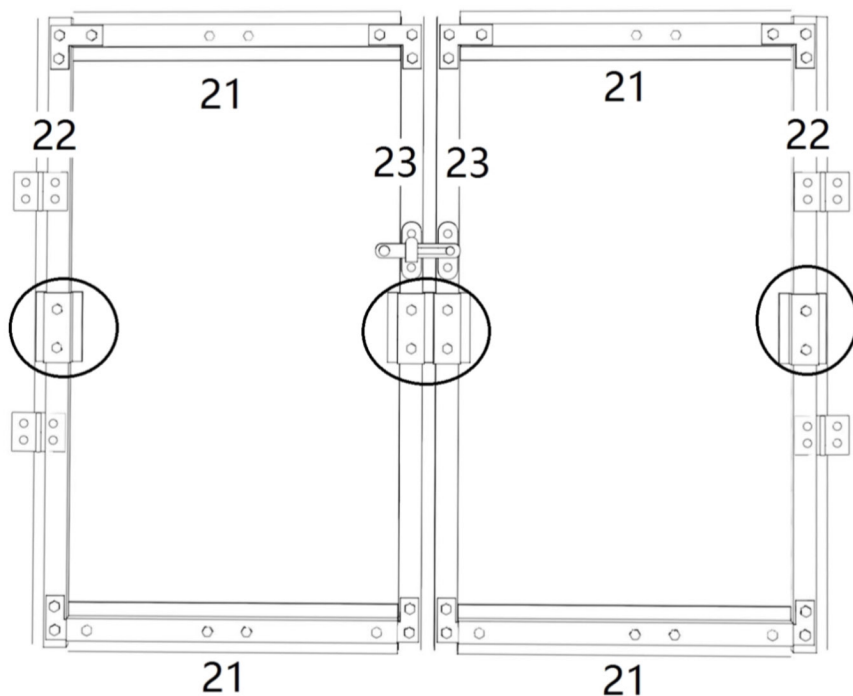

zadní strana

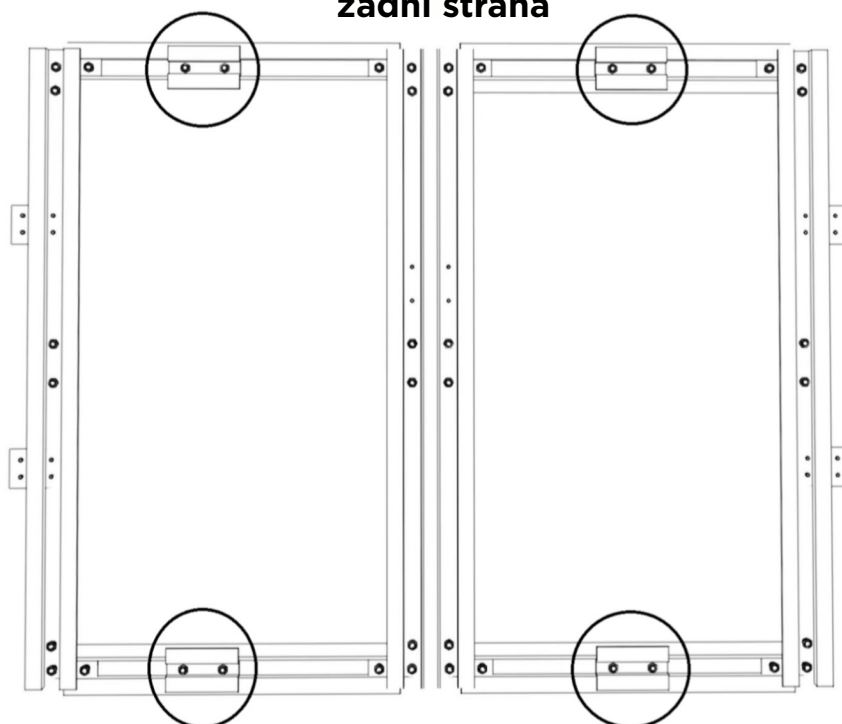
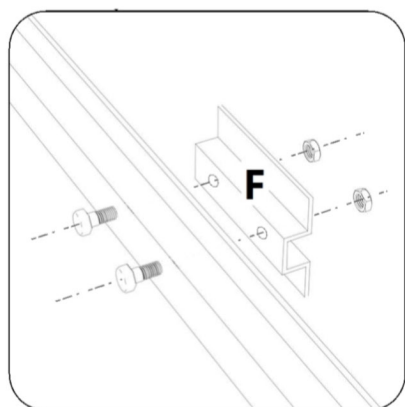

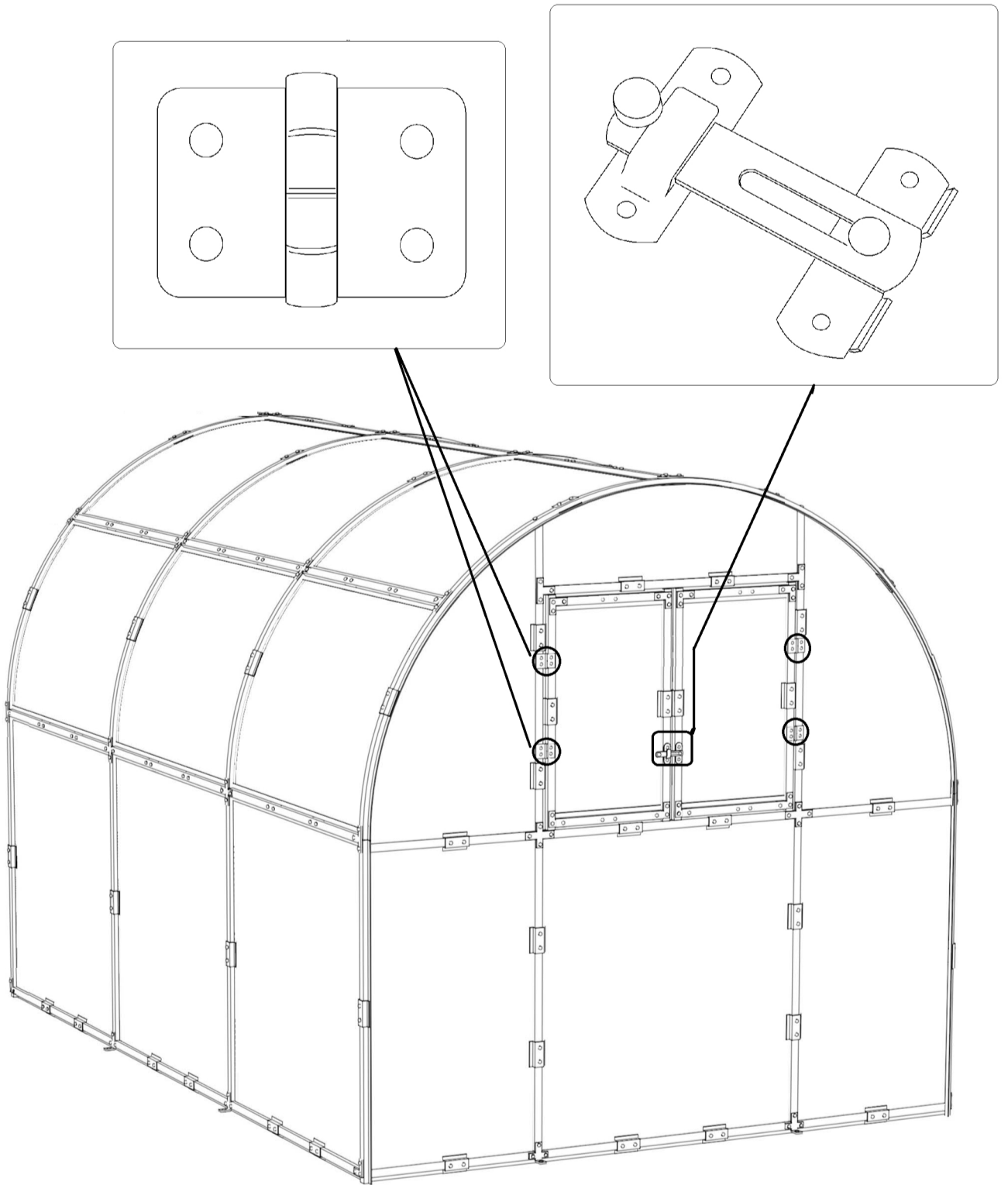

Připevněte panty a madla

OMEZOVAČ OTEVŘENÍ OKNA

Pro instalaci háčku pro zajištění zvolte pozici dle obrázku níže. Oko háčku stačí k profilu přilepit. Pokud si však nebudete jisti pevností zajištění háku, můžete jej k profilu přišroubovat.

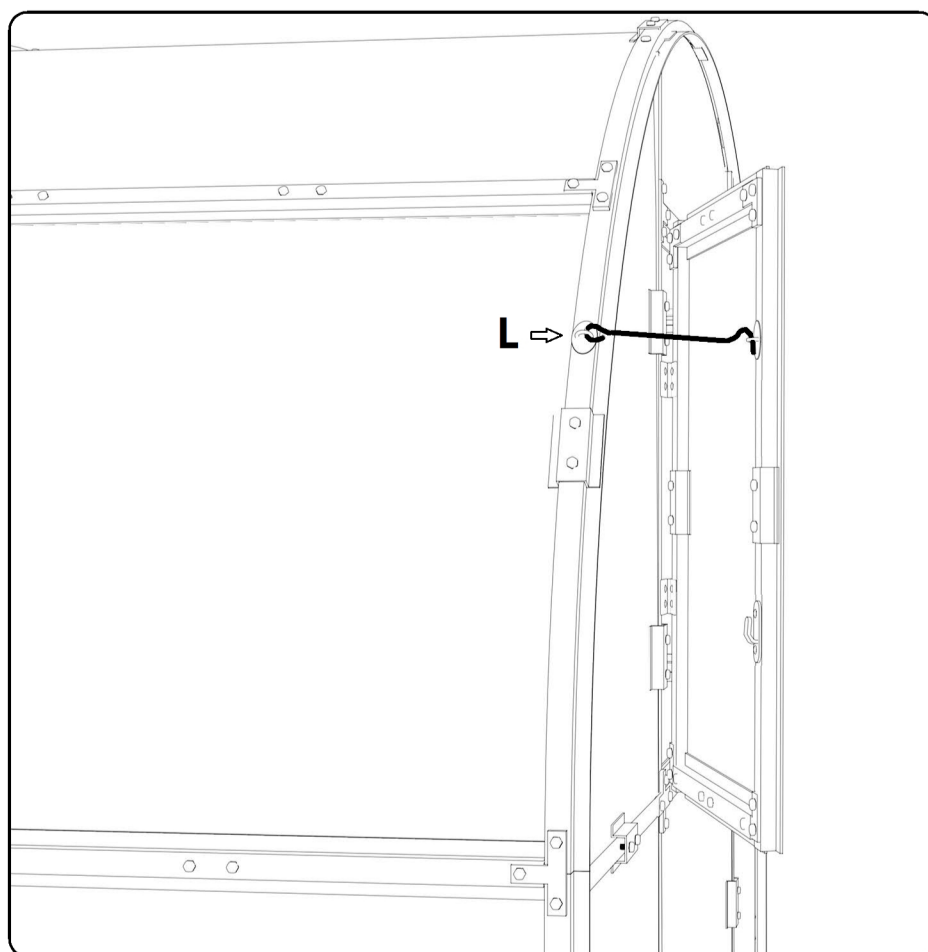

■ PROTECO®

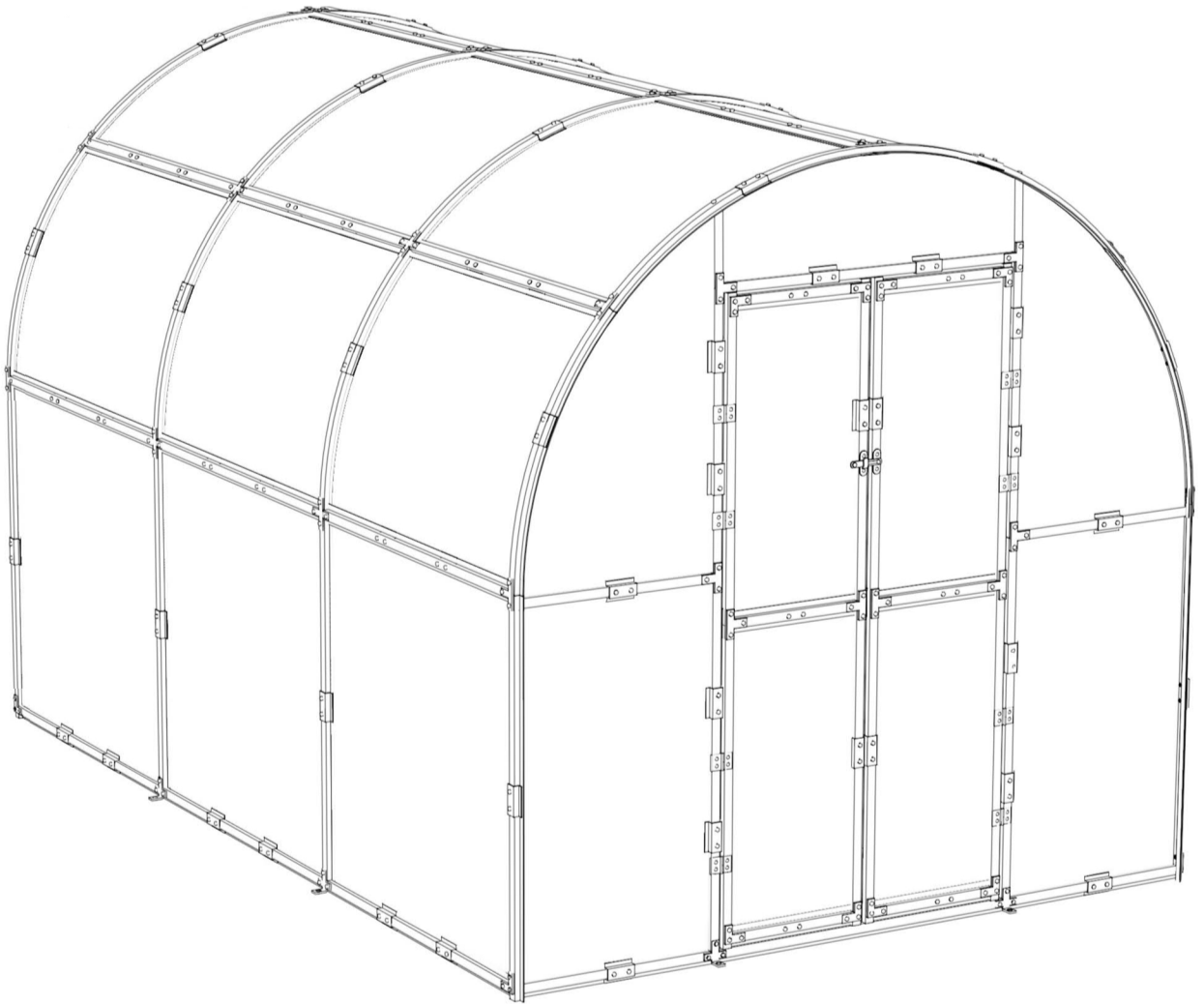

Výrobce:
PROTECO nářadí s.r.o.
Radlická 2487/99
Praha 5 150 00
www.proteco-naradi.cz